

HIG

Horeca Industry Group



14 Buffet & accessories

Buffet y accesorios
Buffet et accessoires



P.386

15 Table service

Servicio de mesa
Arts de table



P.454

16 Bar & coffee

Bar y cafetería
Bar et cafétéria



P.488

HIG

Horeca Industry Group

=

pujadas
A YOLLRATH COMPANY

Partner



14 Buffet & accessories

Buffet y accesorios
Buffet et accessoires

15 Table service

Servicio de mesa
Arts de table

16 Bar & coffee

Bar y cafetería
Bar et cafétéria



14.1 DISPLAY STANDS & BASKETS	386
<i>PRESENTACIÓN Y EXPOSITORES PRÉSENTOIRS ET PRÉSENTOIRS CORBEILLES</i>	
14.2 PROTECTION AND COVERS	394
<i>PROTECCIÓN Y TAPAS PROTECTION ET COUVERCLES</i>	
14.3 BRONZE COOKWARE	398
<i>BATERÍA DE COCINA BRONCE BATTERIE DE CUISINE BRONZE</i>	
14.4 COOL-LINE COLLECTION	400
14.5 SUPER SHAPES	402
<i>BUFFET PRESENTATION STEAM TABLE PANS CUBETAS PRESENTACIÓN BUFFET BACS PRÉSENTATION BUFFET</i>	
14.6 MIRAMAR® COOKWARE	406
<i>BATERÍA DE COCINA PARA PRESENTACIÓN BATTERIE DE CUISINE-PRÉSENTATION</i>	
14.7 CUBIC	412
14.8 CHAFERS & DISPENSERS	428
<i>CHAFINGS Y DISPENSADORES CHAFERS ET DISTRIBUTEURS</i>	
14.9 BOWLS & SERVING TRAYS	436
<i>BOLS & BANDEJAS DE SERVICIO BOLS & PLATEAUX</i>	
14.10 SERVING TOOLS	440
<i>UTENSILIOS DE SERVICIO USTENSILES DE SERVICE BUFFET</i>	
14.11 SIGNS	450
<i>SEÑALIZACIÓN / SIGNALIZATION</i>	

15.1 MINIATURES	454
<i>MINIATURAS MINIATURES</i>	
15.2 TABLE PRESENTATION	462
<i>PRESENTACIÓN DE MESA PRÉSENTATION TABLE</i>	
15.3 TABLE SERVICE	479
<i>SERVICIO DE MESA SERVICE DE TABLE</i>	

16.1 BEVERAGE TROLLEY	488
<i>CARRO BEBIDAS TCHARIOT BOISSON</i>	
16.2 BAR	491
16.3 TEA & COFFEE SERVICE	502
<i>TÉ Y CAFETERÍA THÉ ET CAFÉTERIA</i>	
16.4 BEVERAGE SERVICE	506
<i>SERVICIO DE BEBIDAS SERVICE À BOISSONS</i>	
16.5 LIDSAVERS AND CUPDISPENSERS	510
<i>DISPENSADORES DE TAPAS Y VASOS DISTRIBUTEUR DE COUVERCLES ET GOBELETS</i>	



14 Buffet & accessories

Buffet y accesorios

Buffet et accessoires



14.1 DISPLAY STANDS & BASKETS	386
<i>PRESENTACIÓN Y EXPOSITORES</i> <i>PRÉSENTOIRS ET PRÉSENTOIRS CORBEILLES</i>	
14.2 PROTECTION AND COVERS	394
<i>PROTECCIÓN Y TAPAS / PROTECTION ET COUVERCLES</i>	
14.3 BRONZE COOKWARE	398
<i>BATERÍA DE COCINA BRONCE / BATTERIE DE CUISINE BRONZE</i>	
14.4 COOL-LINE COLLECTION	400
14.5 SUPER SHAPES	402
<i>BUFFET PRESENTATION STEAM TABLE PANS</i> <i>CUBETAS PRESENTACIÓN BUFFET / BACS PRÉSENTATION BUFFET</i>	
14.6 MIRAMAR® COOKWARE	406
<i>BATERÍA DE COCINA PARA PRESENTACIÓN</i> <i>BATTERIE DE CUISINE-PRÉSENTATION</i>	
14.7 CUBIC	412
14.8 CHAFERS & DISPENSERS	428
<i>CHAFINGS Y DISPENSADORES / CHAFERS ET DISTRIBUTEURS</i>	
14.9 BOWLS & SERVING TRAYS	436
<i>BOLS & BANDEJAS DE SERVICIO / BOLS & PLATEAUX</i>	
14.10 SERVING TOOLS	440
<i>UTENSILIOS DE SERVICIO / USTENSILES DE SERVICE BUFFET</i>	
14.11 SIGNS	450
<i>SEÑALIZACIÓN / SIGNALIZATION</i>	

14.1 Display stands & baskets

Presentación y expositores
Présentoirs et présentoirs corbeilles



NEW!

P598001 One tier flat display stand

Expositor metálico recto de un nivel
Présentoir métallique droit à un niveau



Baskets not included
Cestas no incluidas
Panniers non inclus



REF	W x D x H cm	€/u	
P598001	45 x 30 x 20,5	33,00	1

P598002 One tier angled display stand

Expositor metálico inclinado de un nivel
Présentoir métallique incliné à un niveau



Baskets not included
Cestas no incluidas
Panniers non inclus



REF	W x D x H cm	€/u	
P598002	45 x 30 x 14,5	37,15	1

P598003 Three tier flat display stand

Expositor metálico recto de 3 niveles
Présentoir métallique droit 3 niveaux



Baskets not included
Cestas no incluidas
Panniers non inclus



REF	W x D x H cm	€/u	
P598003	30 x 24 x 51,5	58,05	1

Display stands & baskets 14.1

Presentación y expositores
Présentoirs et présentoirs corbeilles

NEW!

P591006 Rectangular metal wire basket

Cesta metálica rectangular
Panier métallique rectangulaire



Suitable for
Combinable con
Adaptable pour
P598001 / P598002

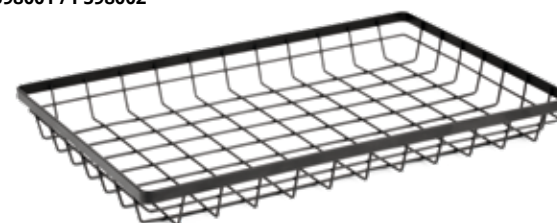

REF	W x D x H cm	€/u	
P591006	45 x 30 x 5	18,95	1

P591007 Rectangular metal wire basket

Cesta metálica rectangular
Panier métallique rectangulaire



Suitable for
Combinable con
Adaptable pour
P598003



REF	W x D x H cm	€/u	
P591007	30 x 22,5 x 5	15,65	1

P595001 Wooden box

Caja de madera
Caisse en bois



dishwasher

Suitable for
Combinable con
Adaptable pour
P598001 / P598002

Stackable
Apilables
Empilables



REF	W x D x H cm	€/u	
P595001	45 x 30 x 5	30,05	1
P595002	45 x 30 x 10	38,75	1

P595003 Wooden box

Caja de madera
Caisse en bois



dishwasher

Suitable for
Combinable con
Adaptable pour
P598003

Stackable
Apilables
Empilables



REF	W x D x H cm	€/u	
P595003	30 x 22 x 5	28,45	1
P595004	30 x 22 x 10	31,70	1

14.1 Display stands & baskets

Presentación y expositores

Présentoirs et présentoirs corbeilles



NEW!

Available in 3 colours: black, silver and gold in a matt finish.

Stackable.

Suitable for food contact.

Double functionality: tray and riser.

Made from 2 mm thick anodised aluminium providing great strength and toughness.

Disponibles en 3 colores: negro, plata y dorado en acabado mate.

Apilables.

Apta para contacto alimentario.

Doble funcionalidad: bandeja y riser.

Realizado en aluminio adonizado de 2 mm de grosor que ofrece gran robustez y resistencia.

Disponibles en 3 couleurs : noir, argent et doré en finition mate.

Empilables.

Adapté au contact alimentaire.

Double fonctionnalité : plateau et riser.

Fabriqué en aluminium anodisé de 2 mm d'épaisseur, ce qui lui confère une grande robustesse et une grande résistance.

P317500 GN 1/1 buffet tray
Bandeja buffet GN 1/1
Plateau buffet GN 1/1

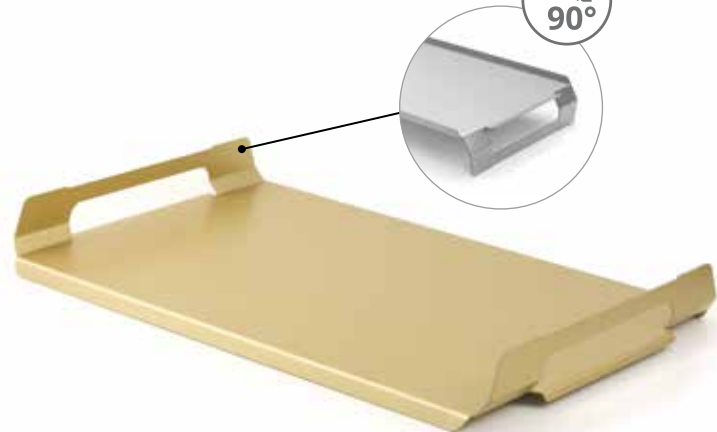

Ref. colour / Ref. color / Ref. couleur couvercle



P317500B / P317500S / P317500G
Adaptable to GN 1/1 trolleys and food transport boxes with guides.

Adaptables a carros GN 1/1 y cajas de transporte de alimentos con guías.

Adaptables aux chariots GN 1/1 et aux caisses de transport de nourriture avec guides.



Click on the top of the handle to stack the trays stable and secure.

Encaje en la parte superior del asa para apilar las bandejas de forma estable y segura.

Enclenchez le dessus de la poignée pour empiler les plateaux de manière stable et sécurisée.

REF	Ext. measures Medidas ext. Dimensions ext. W x D x H cm	Usable surface Superficie útil Surface utile cm	€/u	📦
P317500B	53 x 32,5 x 6,5	49,2 x 31	47,95	1
P317500S	53 x 32,5 x 6,5	49,2 x 31	47,95	1
P317500G	53 x 32,5 x 6,5	49,2 x 31	47,95	1



NEW!

Display stands & baskets 14.1

Presentación y expositores

Présentoirs et présentoirs corbeilles

P317100 Service and buffet trays
Bandejas de servicio y buffet
Plateaux de service et de buffet

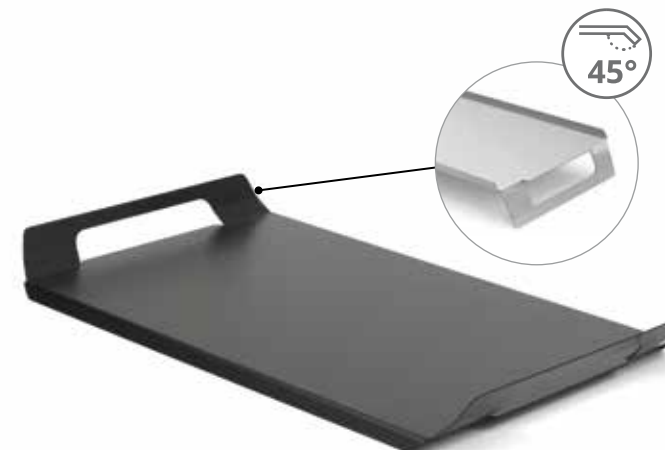

REF	Ext. measures Medidas ext. Dimensions ext. W x D x H cm	Usable surface Superficie útil Surface utile cm	€/u	📦
P317100B	53 x 32,5 x 4,6	45,5 x 31	47,95	1
P317100S	53 x 32,5 x 4,6	45,5 x 31	47,95	1
P317100G	53 x 32,5 x 4,6	45,5 x 31	47,95	1

P317200 Service and buffet trays
Bandejas de servicio y buffet
Plateaux de service et de buffet



REF	Ext. measures Medidas ext. Dimensions ext. W x D x H cm	Usable surface Superficie útil Surface utile cm	€/u	📦
P317200B	43,4 x 32,5 x 4,6	36 x 31	38,50	1
P317200S	43,4 x 32,5 x 4,6	36 x 31	38,50	1
P317200G	43,4 x 32,5 x 4,6	36 x 31	38,50	1

P317300 Service and buffet trays
Bandejas de servicio y buffet
Plateaux de service et de buffet

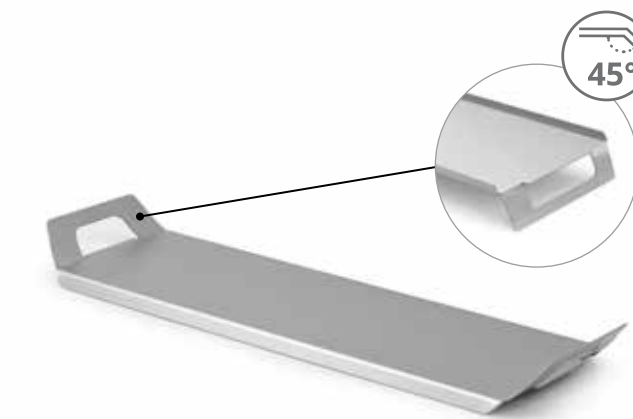

REF	Ext. measures Medidas ext. Dimensions ext. W x D x H cm	Usable surface Superficie útil Surface utile cm	€/u	📦
P317300B	51,5 x 18,5 x 4	45,5 x 17	34,95	1
P317300S	51,5 x 18,5 x 4	45,5 x 17	34,95	1
P317300G	51,5 x 18,5 x 4	45,5 x 17	34,95	1

P317400 Service and buffet trays
Bandejas de servicio y buffet
Plateaux de service et de buffet

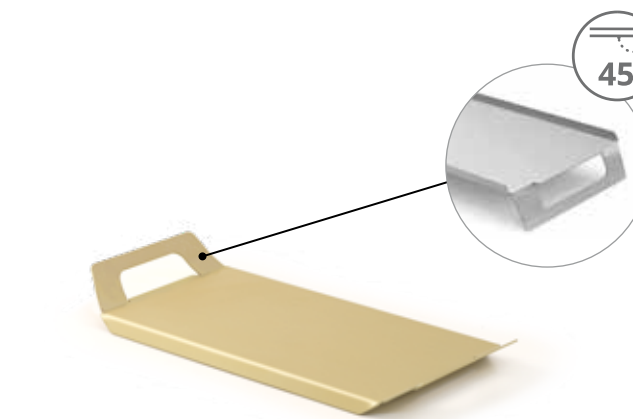

REF	Ext. measures Medidas ext. Dimensions ext. W x D x H cm	Usable surface Superficie útil Surface utile cm	€/u	📦
P317400B	39 x 19,5 x 4	33 x 18	30,95	1
P317400S	39 x 19,5 x 4	33 x 18	30,95	1
P317400G	39 x 19,5 x 4	33 x 18	30,95	1

14.1 Display stands & baskets

Presentación y expositores
Présentoirs et présentoirs corbeilles

Mt
Metal

**BUF
FET**

**BEST
SELLER**



P596110 Black GN wire basket
Cesta rejilla GN negra
Pannier metalique GN noir



1/1

REF	Mod	W x D x H cm	€ / u	📦
P596110	1/1	52 x 31,5 x 12	39,10	6
P596111	1/1	52 x 31,5 x 16	48,60	6

P596120 Black GN wire basket
Cesta rejilla GN negra
Pannier metalique GN noir



1/2

REF	Mod	W x D x H cm	€ / u	📦
P596120	1/2	31,5 x 25,5 x 12	27,50	6
P596121	1/2	31,5 x 25,5 x 16	36,70	6

P596130 Black GN wire basket
Cesta rejilla GN negra
Pannier metalique GN noir



1/3

REF	Mod	W x D x H cm	€ / u	📦
P596130	1/3	31,5 x 17 x 12	24,55	6
P596131	1/3	31,5 x 17 x 16	30,10	6

Suitable for
Compatible con / Adaptable pour



Display stands & baskets 14.1

Presentación y expositores
Présentoirs et présentoirs corbeilles

Ba
Bamboo

**BUF
FET**

NATURAL
FIBERS



Dos posiciones: derecho y revés.
Two positions: right and reverse.
Deux positions: droit et envers
Zwei Positionen: rechts und rückwärts.



P59511 GN buffet bamboo box
Caja GN bambú buffet
Présentoir GN buffet bambou



1/1

REF	Mod	H cm	€ / u	📦
P595110	1/1	10	86,65	1
P595111	1/1	20	110,45	1

P59512 GN buffet bamboo box
Caja GN bambú buffet
Présentoir GN buffet bambou



1/2

REF	Mod	H cm	€ / u	📦
P595120	1/2	10	60,40	1
P595121	1/2	20	76,15	1

P59513 GN buffet bamboo box
Caja GN bambú buffet
Présentoir GN buffet bambou



1/3

REF	Mod	H cm	€ / u	📦
P595130	1/3	10	52,10	1
P595131	1/3	20	65,95	1

P59510 Tray - Lid for GN buffet bamboo box
Bandeja - Tapa para caja GN bambú buffet
Plateau - Couverture pour présentoir GN buffet bambou



REF	Mod	H cm	€ / u	📦
P595100	1/1	2	50,10	1
P595200	1/2	2	33,80	1
P595300	1/3	2	31,95	1

Suitable for
Compatible con / Adaptable pour



14.1 Display stands & baskets

Presentación y expositores
Présentoirs et présentoirs corbeilles



P59711 Buffet displayer
Expositor buffet
Présentoir buffet

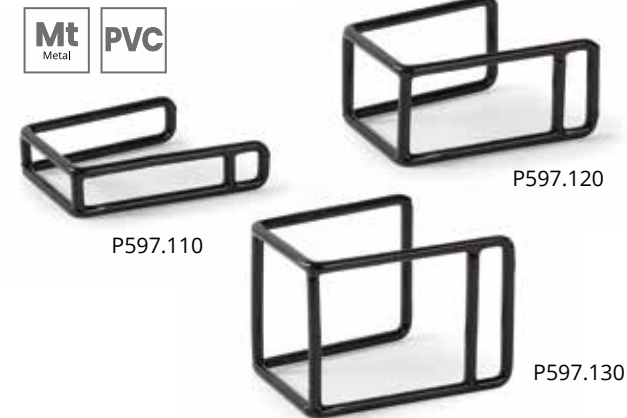

REF	W x D x H cm	€/u	
P597110	12,5 x 10,5 x 3	6,45	1
P597120	12,5 x 10,5 x 6	7,75	1
P597130	12,5 x 10,5 x 9	9,10	1

19196 Angled Adaptor Plate
Placa adaptadora angular
Plaque intermédiaire inclinée



Elevates pans to enhance food presentation
Eleva las cubetas para mejorar la presentación de los alimentos
Élévage des bacs pour améliorer la présentation des aliments

REF	W x D x H cm	Type / Tipo	€/u	
19196	53 x 32,5 x 7,0	1 GN 1/1 (6°)	119,30	2

P597170 Retractable display stand
Expositor buffet extensible
Présentoir buffet rétractable



REF	Max cm	Min cm	H cm Min / Max	€/u	
P597170	53 x 32,5	32,5 x 17,6	6,5 / 10	58,80	1

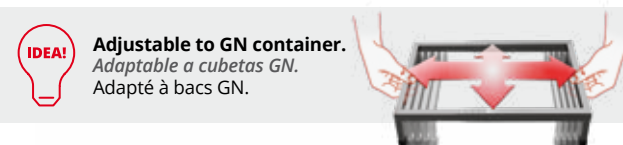

Display stands & baskets 14.1

Presentación y expositores
Présentoirs et présentoirs corbeilles

P59714 Buffet displayer
Expositor buffet
Présentoir buffet

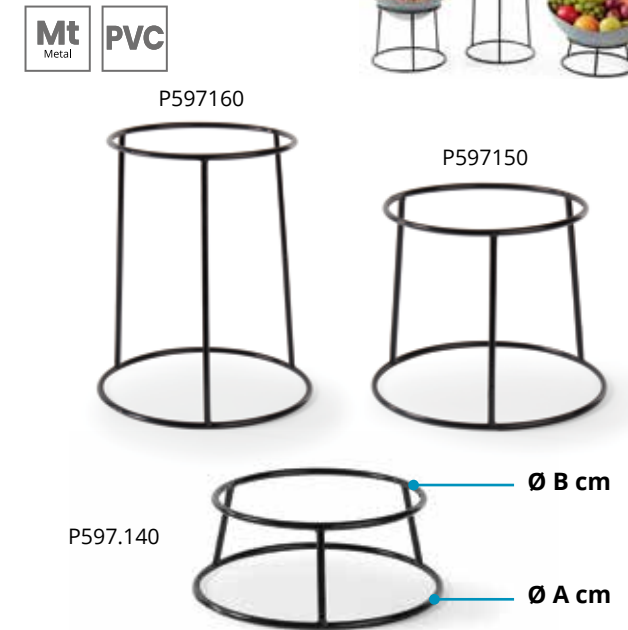

REF	Ø A cm	Ø B cm	H cm	€/u	
P597140	25	21	10	13,80	1
P597150	25	21	20	16,45	1
P597160	25	21	30	19,10	1

46009 Set of 3 Square Bent Risers
Juego 3 expositores ángulos redondos
Jeu de 3 socles carrés aux angles arrondis

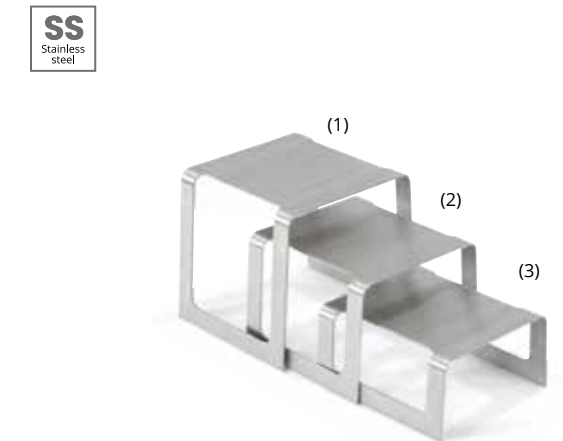

Brushed Stainless Steel
Acero inoxidable pulido
Inox brossé

REF	W x D x H cm	€/u	
46009	(1) 20,3 x 20,3 x 20,3 (2) 20,3 x 19,1 x 15,2 (3) 20,3 x 17,8 x 10,2	217,80	1

4600960 Set of 3 Square Bent Risers
Juego 3 expositores ángulos redondos
Jeu de 3 socles carrés aux angles arrondis

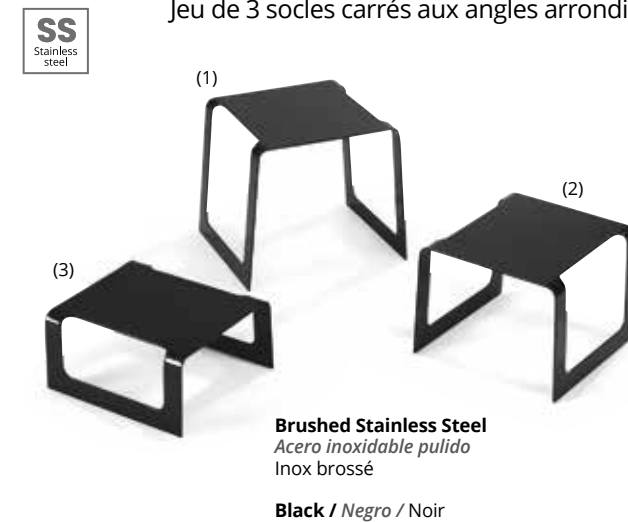

REF	W x D x H cm	€/u	
4600960	(1) 20,3 x 20,3 x 20,3 (2) 20,3 x 19,1 x 15,2 (3) 20,3 x 17,8 x 10,2	265,60	1

See products on
Ver productos en / Voir produits en page

Round bowl
Bol redondo
Bol rond

P. 363



Display plate
Soporte presentación
Présentoir



P. 373



14.2 Protection and covers

Protección y tapas
Protection et couvercles

P19060 Mobile and ajustable breath guards Protección Anti-aliento regulable Pare-haleine ajustable



REF	W x D x H cm	€ / u	
P19060	60 x 45 x 38	386,70	1
P19090	90 x 45 x 38	476,95	1
P19120	120 x 45 x 38	567,15	1

Adjustable in tilt and height to adapt to different spaces. Protect exposed foods without losing visibility.

Ajustable en inclinación y altura para adaptarse a diferentes espacios. Protege los alimentos expuestos sin perder visibilidad.

Hauteur et inclinaison réglables pour s'adapter à tous les espaces des buffets. Protège et laisse visible les aliments exposés.

MBA92821 Mobile Acrylic Breath Guards Protección acrílica Anti-aliento Pare-haleine mobiles en acrylique



Bolsa de nylon incluida.
Nylon bag included.
Sac en nylon compris.
Nylontasche nicht enthalten.



REF	W x D x H cm	€ / u	
MBA92821	121,9 x 49,5 x 40,6	925,50	1

Convenient, durable and portable solution to cover food serving areas. Folds down flat and secures with magnetic latches - for ease in transporting. 1 cm thick acrylic panels can be securely fastened in place with easy thumb turns.

Solución para cubrir superficies de alimentos. Paneles acrílicos de 1 cm de grosor. Duradero. De fácil montaje y transporte.

Solution pratique, durable et portable pour couvrir les zones de service des aliments.

Protection and covers 14.2

Protección y tapas
Protection et couvercles

P590008 Dome cover Tapa campana Couvercle cloche



REF	Ø cm	H cm	€ / u	
P590008	21	17,5	31,10	1
P590009	26	20,0	36,30	1
P590010	31	23,5	41,45	1



Fitting system with the base that provides stability

Sistema de encaje con la base que aporta estabilidad

Système d'assemblage avec la base qui assure la stabilité



P22361 Display tray Bandeja presentación Plateau présentation



REF	Ø cm	H cm	€ / u	
P22361	22,7	1,5	8,00	1
P22362	27,8	1,5	10,15	1
P22363	32,7	1,5	14,30	1

P590011 Hinged cover Tapa con visagra Couvercle articulé



REF	Ø cm	€ / u	
P590011	23,0	15,50	1
P590012	26,5	18,65	1



IDEA! P590008 + P22361
P590009 + P22362
P590010 + P22363

P2236 Stand Stan Base



Suitable for
Combinable con
Adaptable pour
P22361 / P22362 / P22363

REF	Ø cm	H cm	€ / u	
P22366	16,5	10	10,30	1
P22367	16,5	18	15,35	1

P22364 Bowl Bol Bol



REF	Ø cm	€ / u	
P22364	22,5	10,35	1
P22365	26,0	17,20	1



IDEA! P590011 + P22364
P590012 + P22365

14.2 Protection and covers

Protección y tapas
Protection et couvercles



P598700 Clear round lid for presentation
Tapa redonda transparente presentación
Couvercle rond transparent pour présentation



REF	Ø cm	H cm	€/u	📦
P598700	22	13,5	16,70	1
P598800	27	16,5	20,95	1

P590005 Round display cabinet
Vitrina redonda
Vitrine ronde



REF	Ø cm	H cm	Base útil Functional basic Base utile Ø cm	€/u	📦
P590005	38	22	31,5	38,10	1
P590006	46	26	37,5	53,75	1

P590001 Rectangular display cabinet
Vitrina rectangular
Vitrine rectangulaire



REF	W x D x H cm	Base útil Functional basic Base utile Ø cm	€/u	📦
P590001	40 x 24,5 x 15,5	34 x 19	49,30	1
P590002	50,5 x 30,5 x 18	44 x 24,5	56,15	1

P590003 Double display cabinet
Vitrina doble
Vitrine double



REF	W x D x H cm	Base útil Functional basic Base utile Ø cm	€/u	📦
P590003	40 x 24,5 x 32	2 x (34 x 19)	88,65	1
P590004	50,5 x 30,5 x 40	2 x (44 x 24,5)	112,20	1

Protection and covers 14.2

Protección y tapas
Protection et couvercles



P904300 Roll-top lid
Tapa roll-top
Couvercle roll-top

1/1



REF	Mod	W x D x H cm	€/u	📦
P904300	1/1	57 x 32,5 x 17,5	74,85	1

P590110 Clear GN lids for presentation
Tapas GN transparentes presentación
Couvercles GN transparents de présentation



P834 GN prectangular lid
Tapa rectangular GN
Couvercle rectangulaire GN

1/1



REF	Mod	W x D x H cm	€/u	📦
P834000	1/1	53 x 32,5 x 10	86,65	6

P835 GN dome lid
Campana GN
Dôme de protection GN

1/1



REF	Mod	W x D x H cm	€/u	📦
P835000	1/1	53 x 32,5 x 19	82,20	6

Suitable for
Compatible con / Adaptable pour

P. 391



P. 351



P. 351

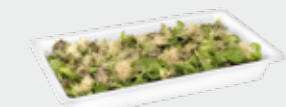

P. 378



14.3 Bronze cookware

Batería cocina bronce
Batterie de cuisine bronze

NEW!

Transparent glass lid with stainless steel rim and black handle.

Tapa de cristal transparente con borde de acero inoxidable y mango en color negro.

Couvercle en verre transparent avec rebord en acier inoxydable et manche noir.

Escape valve for steam

Válvula de salida de vapor
Clapet de sortie de la vapeur

Exterior painted in an elegant bronze colour.

Exterior pintado en elegante color bronce.

Extérieur avec revêtement bronze élégant.

Made of cast aluminium with high resistance to deformation and excellent thermal performance.

Fabricada en aluminio de fundición de gran resistencia a la deformación y con excelentes prestaciones térmicas.

Fabriqué en fonte d'aluminium très résistante à la déformation et doté d'excellentes performances techniques.

Ground base

Fondo torneado
Fond dressé

Elegant, robust, versatile

Elegante, robusta, versátil / Élégante, solide, polyvalente



CA
Cast
Aluminium

NEW!



Bronze cookware 14.3

Batería cocina bronce
Batterie de cuisine bronze

P1520 Rotisserie
Rustidera
Plat à rôtir



REF	W x D x H cm	€/u	☐
P152035B	35 x 25 x 7,5	79,20	1
P152935	Transparent lid Tapa transparente Couvercle transparent	20,70	1

P1410 Shallow casserole without lid
Cazuela baja sin tapa
Cocotte sans couvercle



REF	Ø cm	H cm	€/u	☐
P141024B	24	5,8	43,95	1
P141028B	28	7,5	56,85	1
P141032B	32	8,0	67,95	1

P1510 Deep casserole without lid
Cazuela alta sin tapa
Braising sans couvercle



REF	Ø cm	H cm	€/u	☐
P151020B	20	9	47,60	1
P151024B	24	10	57,65	1
P151028B	28	12	67,55	1

P1540 Glass lid with stainless steel rim
Tapa de cristal con borde de acero inoxidable
Couvercle en verre avec rebord en acier inoxydable

Cr
Crystal



REF	Ø cm	€/u	☐
P154020	20	9,85	1
P154024	24	11,10	1
P154028	28	12,30	1
P154032	32	13,55	1

14.4 Cool-line

IDEA! Ideal for heated buffets
Ideal para buffet caliente
Idéal pour buffets chauffées

P1311 Enamelled steel GN container
Cubeta GN de acero esmaltado
Bac GN en acier émaillé



Suitable for all types of temperature-maintaining plates.
Apto para todo tipo de placa mantenedora de temperatura.
Convient à tous types de plaques de maintien en température.



P131165



P131120

NEW!

REF	Type Tipo	H cm	€/u	☐
P131120	1/1	2,0	47,95	1
P131165	1/1	6,5	59,95	1
P131220	1/2	2,0	37,55	1
P131265	1/2	6,5	49,90	1

P4909 Paella pan with lid
Paellera con tapa
Plat à paella avec couvercle

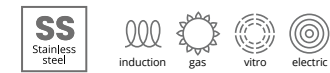

EXCLUSIVE



Ref. colour / Ref. color / Ref. couleur couvercle



REF	Ø cm	H cm	Lts	€/u	☐
P490928 + COLOR	28	6	3,7	138,60	1
P490932 + COLOR	32	6	4,7	156,85	1

See products on
Ver productos en / Voir produits en page **P. 54**

Cookware
Batería de cocina
Batterie de cuisine



See products on
Ver productos en / Voir produits en page **P. 71**

Fry pans
Sartenes
Poêles



Cool-line 14.4



P1106F3 Non-stick sandwich bottom GN container
Cubeta GN antiadherente con fondo difusor
Bac GN anti-adhésive avec fond thermo-diffuseur

PATENTED EXCLUSIVE

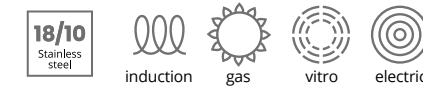

IDEA! Ideal for buffet presentations.
Ideal para presentación buffet.
Idéal pour présentation buffet.

Ref	Type Tipo	H mm	Lts	€/u	☐
P1106F3A	1/1	6,5	8,30	201,75	1
P1106F3N	1/1	6,5	8,30	201,75	1
P1106F3R	1/1	6,5	8,30	201,75	1
P1106F3G	1/1	6,5	8,30	201,75	1
P1106F3	1/1	6,5	8,30	201,75	1
P1206F3A	1/2	6,5	4,10	132,35	1
P1206F3N	1/2	6,5	4,10	132,35	1
P1206F3R	1/2	6,5	4,10	132,35	1
P1206F3G	1/2	6,5	4,10	132,35	1
P1206F3	1/2	6,5	4,10	132,35	1

P1106F3A



P1106F3R



P1106F3



Ref. colour / Ref. color / Ref. couleur couvercle



P1106F3N



P1106F3G



14.5 Super shapes

Buffet presentation steam table pans

Cubetas presentación buffet / Bacs présentation buffet



PATENTED **EXCLUSIVE**

Presentation of food in chafers, heated or refrigerated buffet lines, display cases, and more.

Presentación de las comidas en chafers, líneas buffet calientes o fríos, vitrinas de presentación y más.

Présentation des plats dans les chafers, les lignes de buffet chauffées ou réfrigérées, les présentoirs et bien plus encore.

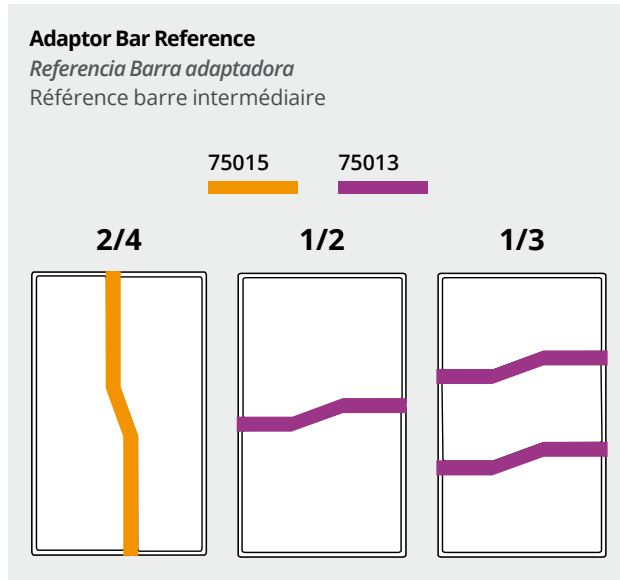

Stackable
Apilable
Empilable



Super shapes 14.5

Buffet presentation steam table pans

Cubetas presentación buffet / Bacs présentation buffet



3101015 Full Oval
Ovalada
Ovale



1/1



REF	W x D x H cm	L	€/u	u
3101015	53 x 32,5 x 5,1	3,7	70,50	6
3101020	53 x 32,5 x 6,5	4,6	78,10	6
3101040	53 x 32,5 x 10	7,8	93,65	6

3102015 Half Oval
Óvalo
Ovale



1/2



REF	cm	L	€/u	u
3102015	26,5 x 32,5 x 5,1	1,6	45,65	6
3102020	26,5 x 32,5 x 6,5	2,1	50,50	6
3102040	26,5 x 32,5 x 10	3,5	61,75	6

3101220 Full Hexagon
Hexágono
Hexagonal



1/1



REF	W x D x H cm	L	€/u	u
3101220	53 x 32,5 x 6,5	5,0	69,65	6
3101240	53 x 32,5 x 10	8,8	90,00	6

3102220 Full Hexagon
Hexágono
Hexagonal



1/2



REF	W x D x H cm	L	€/u	u
3102220	26,5 x 32,5 x 6,5	2,1	45,30	6

3101120 Full Kidney
Reniforme
Rein



1/1



REF	W x D x H cm	L	€/u	u
3101120	53 x 32,5 x 6,5	4,8	70,50	6

14.5 Super shapes

Buffet presentation steam table pans

Cubetas presentación buffet / Bacs présentation buffet



3102120 Half Kidney
Reniforme
Rein



1/2



REF	W x D x H cm	L	€/u	📦
3102120	26,5 x 32,5 x 6,5	2,1	45,65	6

3100020 Long Wild Pan
Wild Pan larga
Wild Pan long



2/4



75015

REF	W x D x H cm	L	€/u	📦
3100020	53 x 16,5 x 6,5	3,5	62,95	6
3100040	53 x 16,5 x 8,9	4,8	84,80	6

3100220 Short Wild Pan
Wild Pan corta
Wild Pan court



1/2



75013

REF	W x D x H cm	L	€/u	📦
3100220	26,5 x 32,5 x 6,5	3,9	62,20	6
3100240	26,5 x 32,5 x 10	6,1	81,60	6

3100320 Third Outer Wild Pan
Wild Pan externa
Troisième Wild Pan extérieur



1/3



75013

REF	W x D x H cm	L	€/u	📦
3100320	17,6 x 32,5 x 6,5	2,5	44,00	6
3100340	17,6 x 32,5 x 10	3,6	60,05	6

3100321 Inner Wild Pan
Wild Pan interna
Troisième Wild Pan intérieur



1/3



75013

REF	W x D x H cm	L	€/u	📦
3100321	17,6 x 32,5 x 6,5	2,5	44,00	6
3100341	17,6 x 32,5 x 10	3,6	60,05	6

75015 Adaptor Bar
Barra adaptadora
Barre intermédiaire



REF	For / Para / Pour	€/u	📦
75015	3100020 / 3100040	23,30	12
75013	3100220 / 3100240 / 3100320 / 3100321 / 3100340 / 3100341	22,10	12

See products on / Ver productos en / Voir produits en page

P. 194

GN St/steel



See products on / Ver productos en / Voir produits en page

P. 203

POLINORM®



14.6 Miramar® cookware

Batería de cocina para presentación
Batterie de cuisine-Présentation



Cookware goes straight from the kitchen to your buffet in the same vessel.

Variety of cookware items or any menu.

La batería pasa directamente de la cocina a su buffet en el mismo recipiente.

Variación de utensilios de cocina para todo tipo de comidas.

Passez directement de la cuisine au buffet sans changer de plat.
Variété d'articles pour tout type de menu.



Miramar® cookware 14.6

Batería de cocina para presentación
Batterie de cuisine-Présentation



Satin-finished interior and exterior

Asas y mangos brillantes
Des poignées ultra-brillantes

Handle design serves as a convenient cover rest

Mangos diseñados para la sujeción de las tapas
La conception des manches et poignées sert de reposecouvert

Mirror-finished handles

Interior y exterior satinados
Finition satinée à l'intérieur et l'extérieur

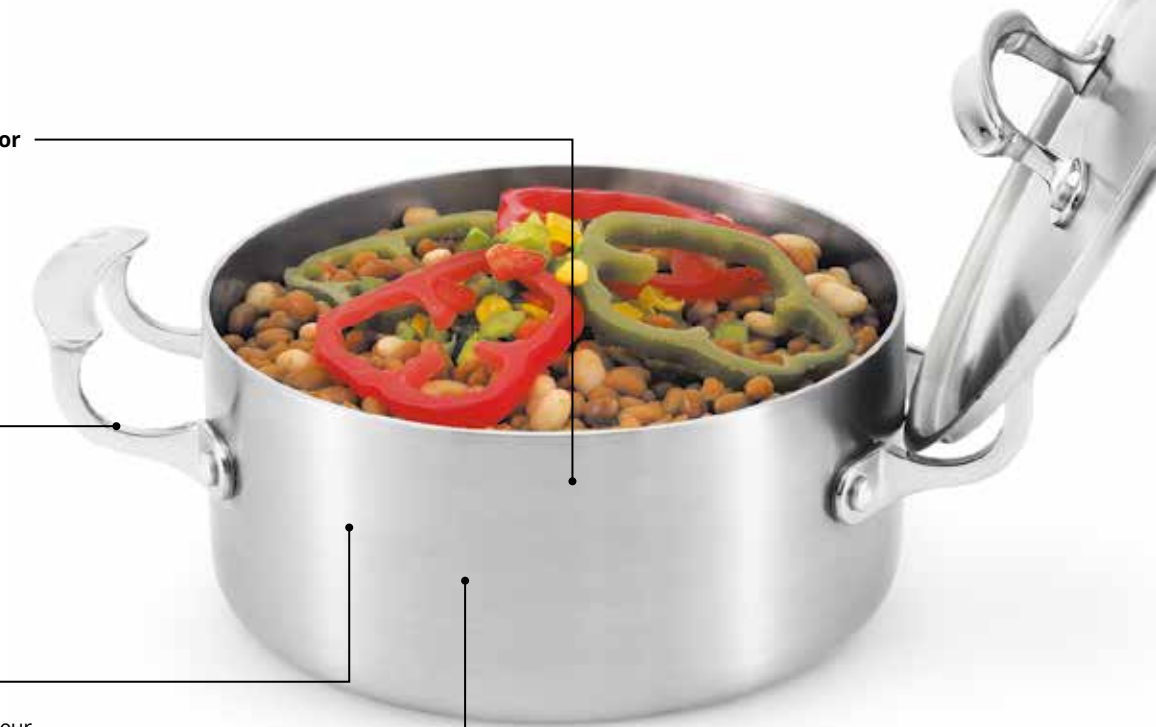

Multi-ply
Multimetal
Multi-metal

St/Steel - Inox

Tri-aluminium

St/Steel - Inox

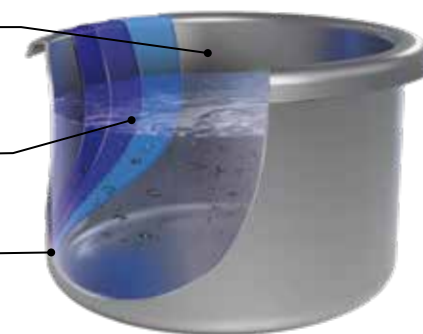

14.6 Miramar® cookware

Batería de cocina para presentación
Batterie de cuisine-Présentation



49410 Casseroles

Cacerola baja con tapa
Faitouts avec couvercle dôme bas



REF	Ø cm	H cm	L	€/u	📦
49410	20,0	9,5	2,9	122,30	1
49411	24,1	11,3	4,8	153,70	1
49441	25,8	18,9	6,6	211,75	1 NEW

49425 Bazier pan

Cacerola baja
Plat à braiser



REF	Ø cm	H cm	L	€/u	📦
49425	30	8,9	6	136,40	1

49413 Sauté Pan

Sartén
Sauteuse



REF	Ø cm	H cm	L	€/u	📦
49416	20,3	5,1	1,2	74,65	1 NEW
49413	26,0	4,8	2,1	107,40	1

49417 French Omelet Pans

Paellera
Poêle à omelette



REF	cm	H cm	L	€/u	📦
49417	20,3 x 20,3	6	1,7	105,60	1
49424	26 x 26	6	2,9	110,60	1

49418 Stir Fry Pan

Sautex bombeado
Wok/plat de service



REF	Ø cm	H cm	L	€/u	📦
49418	30,2	9,4	4,9	149,60	1
49428	32,1	9,2	6,0	141,05	1

49430 Sauce Pans

Cazo
Casserole



REF	Ø cm	H cm	L	€/u	📦
49414	15,9	9,5	1,9	96,45	1
49430	14,0	6,8	0,9	93,60	1 NEW

Miramar® cookware 14.6

Batería de cocina para presentación
Batterie de cuisine-Présentation



49432 Food Pans

Fuente
Plat



REF	W x D x H cm	L	€/u	📦
49432	37,3 x 30 x 5,1	4,4	146,45	1 NEW
49435	29,1 x 23,6 x 5,1	2,6	145,25	1
49433	37,3 x 30 x 5,1	4,4	168,50	1

49431 French Oven with cover

Fuente Horno con tapa
Cocotte avec couvercle



REF	W x D x H cm	L	€/u	📦
49431	363 x 282 x 9,7	6,6	252,55	1

8230210 Oval presentation dish

Fuente presentación ovalada
Fontaine de présentation ovale



REF	W x D x H cm	L	€/u	📦
8230210	33,3 x 22,5 x 6,4	1,9	121,25	1
8231420	48,4 x 30,2 x 5,1	2,8	160,40	1

49420 Oval Au Gratin

Fuente para gratinar
Plat à gratin ovale



* Mirror-finished interior
Acabado brillante
Ultra-brillante

REF	W x D x H cm	L	€/u	📦
49420	25,4 x 19,1 x 5,2	1,7	112,15	1
49412*	30,5 x 21,6 x 5,1	2,5	116,15	1
49442	40,6 x 22,9 x 5,1	3,5	208,00	1 NEW
49445	52,3 x 22,9 x 10,2	6,6	259,00	1 NEW

49429 Covers

Tapa
Couvercles



REF	For / Para / Pour	Ø cm	H mm	€/u	📦
49429	49428	35,6	120	63,60	1
49426	49418 - 49425	32,4	102	58,55	1
49419	49416 - 49417	20,3	51	36,15	1
49423	49413 - 49424	27,3	51	39,70	1
49427	49430	14,9	51	25,65	1 NEW

8231810 Rectangular presentation dish

Fuente presentación rectangular
Fontaine de présentation rectangulaire



REF	W x D x H cm	L	€/u	📦
8231810	33,2 x 27 x 2,5	1,5	96,85	1
8230720	33,2 x 27 x 7	3,2	129,00	1

14.6 Miramar® cookware

Batería de cocina para presentación
Batterie de cuisine-Présentation

TEMPLATES PLANTILLAS GABARITS

Stainless Steel Plain / Acero inox. / Inox
Resin / Resina / Résine
Night Sky / Negro / Bleu nuit

+150°C



8242014 One large and one small round
Plantilla agujeros redondo grande y pequeño
Une grande découpe ronde et une petite découpe ronde

1/1



REF	cm	€/u	1
8242014	53,6 x 32,4	235,55	1
8242010	53,6 x 32,4	189,00	1

8242314 One large oval
Plantilla agujero oval grande
Une grande découpe ovale

1/1



REF	cm	€/u	1
8242314	53,6 x 32,4	235,55	1
8242310	53,6 x 32,4	189,00	1

8242414 One large round and one small round
Plantilla agujeros redondo grande y pequeño
Une grande découpe ronde et une petite découpe ronde

1/1



REF	cm	€/u	1
8242414	53,6 x 32,4	235,55	1

8242514 Two large round
Plantilla agujeros redondos grandes
2 grandes découpes rondes

1/1



REF	cm	€/u	1
8242514	53,6 x 32,4	235,55	1

8242614 One large round
Plantilla agujero redondo grande
Une grande découpe ronde

1/1



REF	cm	€/u	1
8242614	53,6 x 32,4	235,55	1
8242610	53,6 x 32,4	189,00	1

8242714 One large oval
Plantilla agujero oval grande
Un grand ovale

1/1



REF	cm	€/u	1
8242714	53,6 x 32,4	235,55	1
8242710	53,6 x 32,4	189,00	1

8240016 Solid baseplate
Plantilla sólida
Modèle solide

1/1



+150°C

8242814 One small food pan
Plantilla para fuente
Un petit bac à aliments

1/1



REF	cm	€/u	1
8242814	53,6 x 32,4	235,55	1
8242810	53,6 x 32,4	189,00	1

8242914 One large food pan
Plantilla para fuente
Un grand bac à aliments

1/1



REF	cm	€/u	1
8242914	53,6 x 32,4	235,55	1

8243014 Two small food pans
Plantilla para fuente
Deux petits bacs à aliments

1/1



REF	cm	€/u	1
8243014	53,6 x 32,4	235,55	1

8243114 One large and one medium oval
Plantilla agujeros ovales grande y pequeño
Une grande découpe ronde et une moyenne découpe ovale

1/1



REF	cm	€/u	1
8243114	53,6 x 32,4	235,55	1

8243214 Two medium oval
Plantilla agujeros redondos medianos
Deux découpes ovales moyennes

1/1



REF	cm	€/u	1
8243214	53,6 x 32,4	235,55	1
8243210	53,6 x 32,4	189,00	1

8243314 One large and one medium round
Plantilla agujeros redondos grande y mediano
Une grande découpe ronde et une moyenne découpe ronde

1/1



REF	cm	€/u	1
8243314	53,6 x 32,4	235,55	1

14.7 CUBIC®

EXCLUSIVE

PATENT PENDING

Modularity that reflects maximum expression

Modularidad a la máxima expresión

Modularité à son expression maximale



Discover the best buffet display, thanks to its:

- It allows to optimize exhibition space
- It reduces assembly and disassembly time
- Ease of transport and storage
- Elegant and original
- It offers multiple and varied combinations

Descubre la mejor presentación de buffet, porque:

- Permite optimizar espacio de exposición
- Reduce el tiempo de montaje y desmontaje
- Facilidad de transporte y almacenaje
- Elegante y original
- Ofrece múltiples y variadas combinaciones

Découvrez la meilleure présentation buffet, grâce à son :

- Permet d'optimiser l'espace d'exposition
- Réduit le temps de montage et de démontage
- Facilité de transport et de stockage
- Élégant et original
- Offre des combinaisons multiples et variées



CUBES / CUBO / CUBES

Top cover convertible on mini shelf, stackable, multicombinations, saving space when storing parts, special waterproof treatment.

Con tapa superior transformable en mini estante, apilables entre sí, múltiples combinaciones posibles, ahorro de espacio durante el almacenaje de las piezas, tratamiento hidrófugo especial.

Couvercle transformable en mini rayon, empilables, multiples combinaisons possibles, gain d'espace pour le stockage des composants, traitement hydrofuge spécial.

SHELVES / ESTANTES / TABLETTES

Three lengths: 50, 80 and 100 cm, two depths: 18 and 35 cm, undeformable wood. Special waterproof treatment.

Tres longitudes: 50, 80 y 100 cm, dos profundidades: 18 y 35 cm, madera indeformable. Tratamiento hidrófugo especial.

Trois longueurs: 50, 80 et 100 cm, deux profondeurs: 18 et 35 cm. Bois indéformable. Traitement hydrofuge spécial.

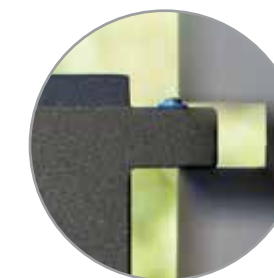
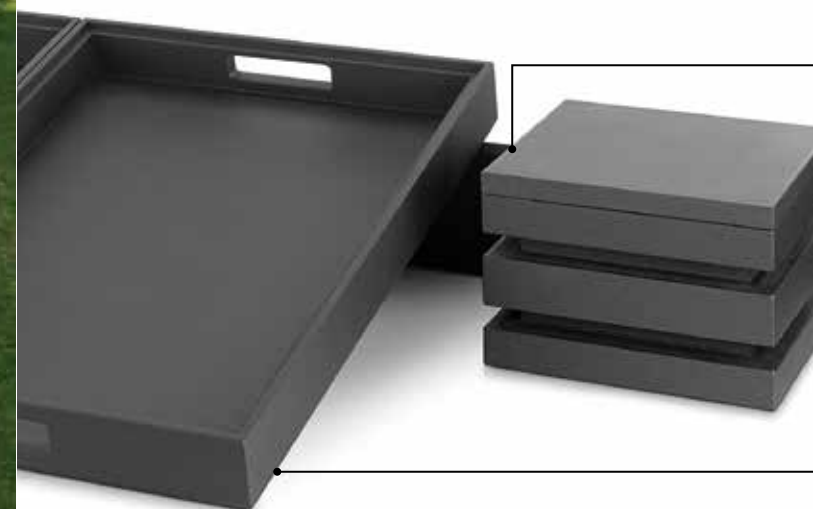

Stackable trays
Bandejas apilables entre sí
Plateaux empilables entre eux

Display buffet cases Muebles presentación buffet Meubles présentation buffet

Suitable for gastronorm sizes
Adaptado a medidas gastronorm
Adaptés aux mesures gastronorme

Made of wood with special waterproof treatment, easy to clean

Fabricados en madera con tratamiento hidrófugo especial, de fácil limpieza

Fabriqué en bois avec un traitement hydrofuge spécial, facile à nettoyer



Wooden buffet serving trolley Carro madera presentación buffet Chariot buffet en bois présentation buffet

Outstanding combination of wood and aluminium
Elegante combinación de madera y aluminio
Combinaison élégante en bois et en aluminium

Suitable for gastronorm sizes
Adaptado a medidas gastronorm
Adaptés aux mesures gastronorme

Possible transformation from an exposer trolley to a presentation table

Posibilidad de convertir el carro expositor en mesa de presentación

Possibilité de transformer le chariot d'exposition en une table de présentation

Wood with special waterproof treatment, easy to clean
Tratamiento hidrófugo especial, de fácil limpieza
Bois avec un traitement hydrofuge spécial, facile à nettoyer



P905504 Presentation kit for 4 square bowls Conjunto soporte 4 bols cuadrados Kit support 4 bols carrés

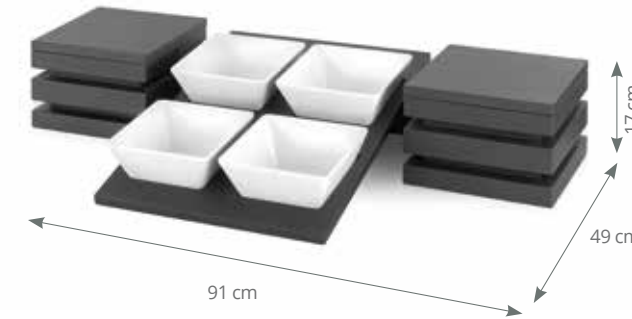

Includes :
2 cubes with lid
1 crossbar 50 cm length
1 displayer for 4 bowls
4 melamine bowls.

Incluye:
2 cubos con tapa
1 travesaño de 50 cm
1 presentador de 4 bols
4 bols de melamina.

Inclus :
2 cubes avec couvercle
1 longeron 50 cm
1 présentoir pour 4 bols
4 bols mélamine.

REF	€/u	
P905504	398,65	1

P905506 Presentation kit for 6 square bowls Conjunto soporte 6 bols cuadrados Kit support 6 bols carrés

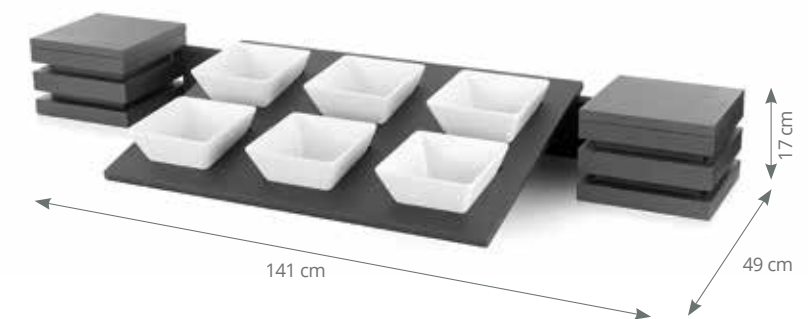

Includes :
2 cubes with lid
1 crossbar 100 cm length
1 displayer for 6 bowls
6 melamine bowls.

Incluye:
2 cubos con tapa
1 travesaño de 100 cm
1 presentador de 6 bols
6 bols de melamina.

Inclus :
2 cubes avec couvercle
1 longeron 100 cm
1 présentoir pour 6 bols
6 bols mélamine.

REF	€/u	
P905506	434,85	1

P905516 Two levels presentation kit for 6 square bowls Conjunto 2 niveles soporte 6 bols Kit support 6 bols carrés deux niveaux

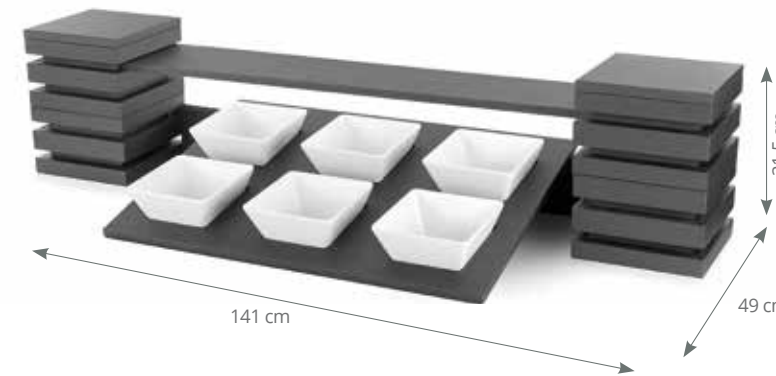

Includes :
4 cubes with lid
1 crossbar 100 cm length
1 displayer for 6 bowls
6 melamine bowls
1 narrow shelf 100 cm

Incluye:
4 cubos con tapa
1 travesaño de 100 cm
1 presentador de 6 bols
6 bols de melamina
1 estante estrecho de 100 cm

Inclus :
4 cubes avec couvercle
1 longeron 100 cm
1 présentoir pour 6 bols
6 bols mélamine
1 tablette étroite 100 cm

REF	€/u	
P905516	711,95	1

P905508 Presentation kit for 8 square bowls Conjunto soporte 8 bols cuadrados Kit support 8 bols carrés

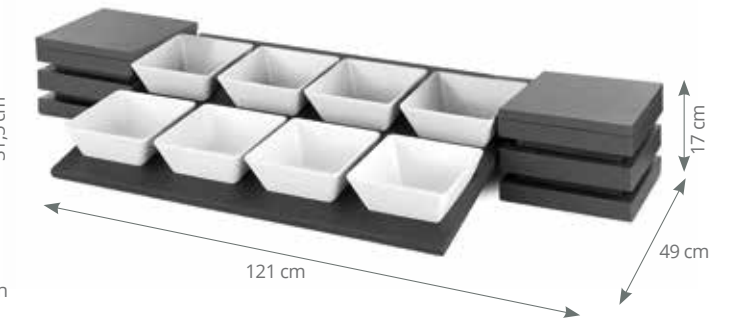

Includes :
2 cubes with lid
1 crossbar 80 cm length
2 displayers for 4 bowls
8 melamine bowls

Incluye:
2 cubos con tapa
1 travesaño de 80 cm
2 presentadores de 4 bols
8 bols de melamina

Inclus :
2 cubes avec couvercle
1 longeron 80 cm
2 présentoirs pour 4 bols
8 bols mélamine

REF	€/u	
P905508	452,10	1

P905518 Two levels presentation kit for 8 square bowls

Conjunto 2 niveles soporte 8 bols
Kit support 8 bols carrés deux niveaux

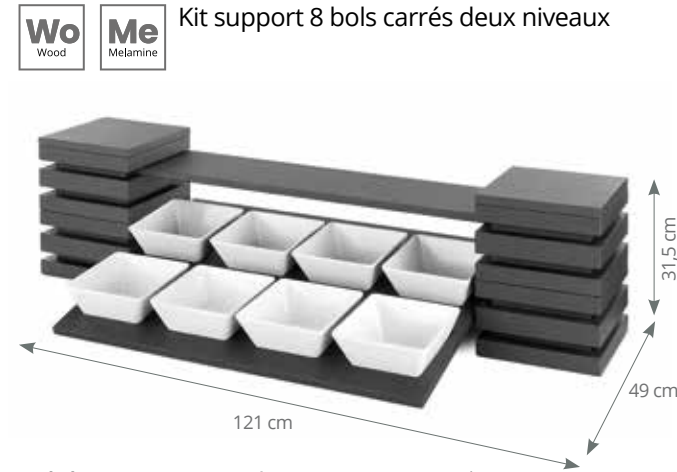

- | | | |
|-------------------------|---------------------------|---------------------------|
| Includes : | <i>Incluye:</i> | Inclus : |
| 4 cubes with lid | 4 cubos con tapa | 4 cubes avec couvercle |
| 1 crossbar 80 cm length | 1 travesaño 80 cm | 1 longeron 80 cm |
| 2 displays for 4 bowls | 2 presentadores de 4 bols | 2 présentoirs pour 4 bols |
| 8 melamine bowls | 8 bols de melamina | 8 bols mélamine |
| 1 narrow shelf 80 cm | 1 estante estrecho 80 cm | 1 tablette étroite 80 cm |

REF	€/u	
P905518	713,10	1

P905400 Basic two levels presentation kit

Conjunto básico estante 2 niveles

Kit basique présentation 2 niveaux



- | | | |
|-----------------------|---------------------------|---------------------------|
| Includes : | <i>Incluye:</i> | Inclus : |
| 4 cubes with lid | 4 cubos con tapa | 4 cubes avec couvercle |
| 1 wide shelf 100 cm | 1 estante ancho 100 cm | 1 tablette large 100 cm |
| 1 narrow shelf 100 cm | 1 estante estrecho 100 cm | 1 tablette étroite 100 cm |

REF	€/u	
P905400	570,95	1

P905310 Two levels presentation kit for 40x40 cm trays

Conjunto 2 niveles bandejas 40x40 cm

Kit présentation 2 niveaux pour plateaux 40x40 cm

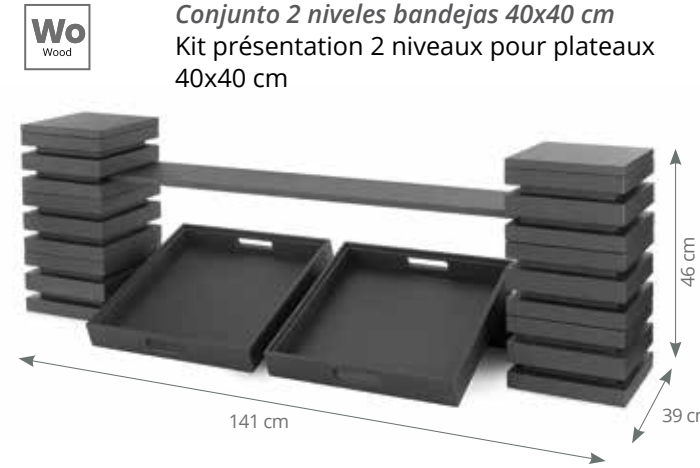

- | | | |
|----------------------------|---------------------------------------|------------------------------------|
| Includes : | <i>Incluye:</i> | Inclus : |
| 6 cubes with lid | 6 cubos con tapa | 6 cubes avec couvercle |
| 1 crossbar 100 cm length | 1 travesaño de 100 cm | 1 longeron 100 cm |
| 2 serving trays 40 x 40 cm | 2 bandejas presentación de 40 x 40 cm | 2 plateaux présentation 40 x 40 cm |
| 1 narrow shelf 100 cm | 1 estante estrecho de 100 cm | 1 tablette étroite 100 cm |

REF	€/u	
P905310	949,85	1

P905320 Two trays 60x40 cm presentation kit

Conjunto 2 bandejas 60x40 cm

Kit présentation pour deux plateaux 60x40 cm

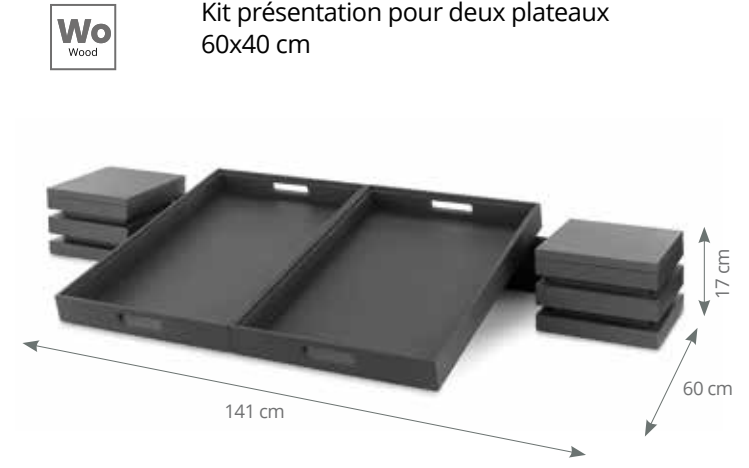

- | | | |
|----------------------------|---------------------------------------|------------------------------------|
| Includes : | <i>Incluye:</i> | Inclus : |
| 2 cubes with lid | 2 cubos con tapa | 2 cubes avec couvercle |
| 1 crossbar 100 cm length | 1 travesaño de 100 cm | 1 longeron 100 cm |
| 2 serving trays 60 x 40 cm | 2 bandejas presentación de 60 x 40 cm | 2 plateaux présentation 60 x 40 cm |

REF	€/u	
P905320	493,80	1

P905410 "L" shape two levels presentation kit

Conjunto estante dos niveles forma "L"

Kit présentation "L" 2 niveles

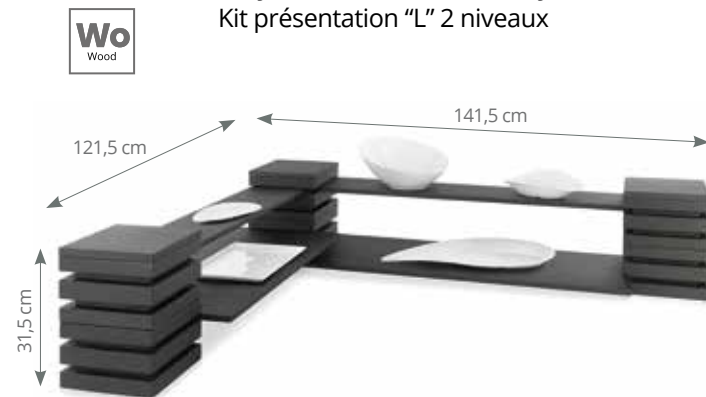

- | | | |
|-----------------------|---------------------------|---------------------------|
| Includes : | <i>Incluye:</i> | Inclus : |
| 6 cubes with lid | 6 cubos con tapa | 6 cubes avec couvercle |
| 1 wide shelf 100 cm | 1 estante ancho 100 cm | 1 tablette étroite 100 cm |
| 1 narrow shelf 100 cm | 1 estante estrecho 100 cm | 1 tablette étroite 100 cm |
| 1 wide shelf 80 cm | 1 estante ancho 80 cm | 1 tablette large 80 cm |
| 1 narrow shelf 80 cm | 1 estante estrecho 80 cm | 1 tablette étroite 80 cm |

REF	€/u	
P905410	904,05	1

P905300 Two trays 40x40 cm presentation kit

Conjunto 2 bandejas presentación 40x40 cm

Kit présentation pour deux plateaux 40x40 cm

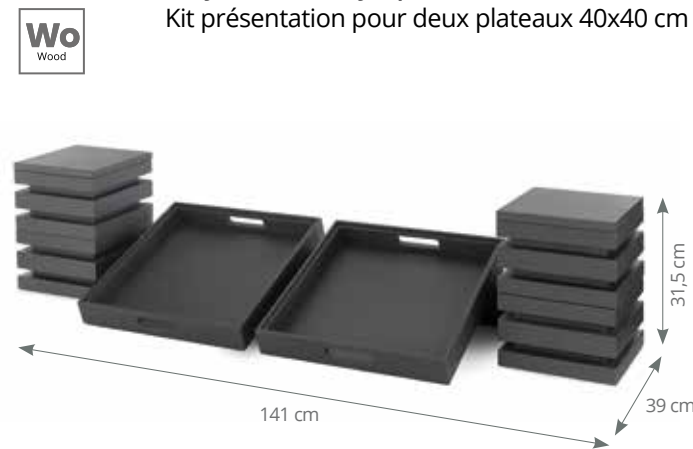

- | | | |
|----------------------------|---------------------------------------|------------------------------------|
| Includes : | <i>Incluye:</i> | Inclus : |
| 4 cubes with lid | 4 cubos con tapa | 4 cubes avec couvercle |
| 1 crossbar 100 cm length | 1 travesaño de 100 cm | 1 longeron 100 cm |
| 2 serving trays 40 x 40 cm | 2 bandejas presentación de 40 x 40 cm | 2 plateaux présentation 40 x 40 cm |

REF	€/u	
P905300	684,05	1

P905340 Two levels for trays 60x40 cm presentation kit

Conjunto 2 niveles para bandejas 60x40 cm

Kit présentation 2 niveles pour plateaux 60x40 cm

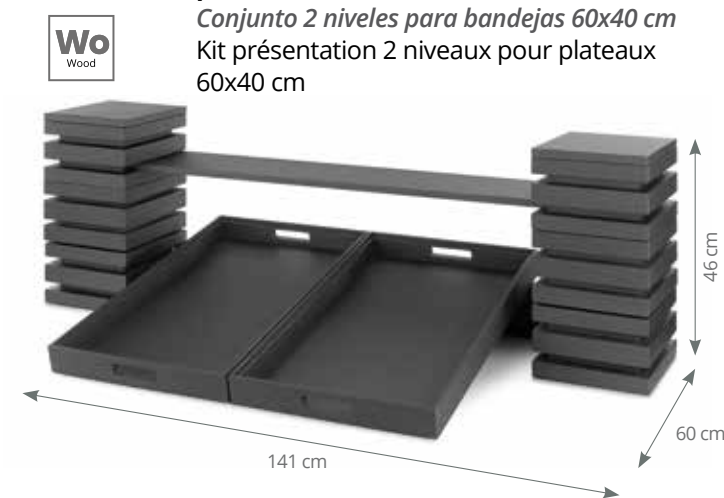

- | | | |
|---------------------------------------|---------------------------------------|------------------------------------|
| Includes : | <i>Incluye:</i> | Inclus : |
| 6 cubes with tapa | 6 cubos con tapa | 6 cubes avec couvercle |
| 1 travesaño de 100 cm | 1 travesaño de 100 cm | 1 longeron 100 cm |
| 2 bandejas presentación de 60 x 40 cm | 2 bandejas presentación de 60 x 40 cm | 2 plateaux présentation 60 x 40 cm |
| 1 estante estrecho de 100 cm | 1 estante estrecho de 100 cm | 1 tablette étroite 100 cm |

REF	€/u	
P905340	981,25	1

P904790 Three levels 2/3 GN stand

Expositor GN 2/3, tres niveles

Présentoir 3 niveaux pour GN 2/3



- Includes / Incluye / Inclus :**
3 GN containers 2/3 20 mm
3 cubetas GN 2/3 20 mm
3 bags GN 2/3 20 mm

REF	W x D x H cm	€/u	
P904790	65 x 38 x 59	261,85	1

P904350 GN skewer serving tray
Bandeja GN presentación pinchos
Plateau GN présentation piques



GN 1/1

Includes:
wooden tray
oak melamine tray
interior skewer stand

Incluye:
bandeja madera
bandeja melamina roble
soporte interior pinchos

Inclus:
plateau bois
plateau mélamine chêne
support intérieur piques

REF	W x D x H cm	Holes Agujeros Ø cm	Piques Pinchos	€/u	
P904350	53,9 x 33,5 x 7,7	0,4	84	266,05	1

P904155 Buffet wine cooler
Enfriador botellas buffet
Rafraîchisseur bouteilles



GN 1/1

Includes:
wooden tray
1/1 GN pan 150 mm

Incluye:
bandeja madera
cubeta GN 1/1 150 mm

Inclus:
plateau bois
bac GN 1/1 150 mm

REF	W x D x H cm	€/u	
P904155	57 x 37 x 14,5	175,30	1

P904720 Napkin and tea & sugar bags dispenser
Servilletero y dispensador bolsas te y azúcar
Distributeur serviettes et des saquettes
thé & sucre

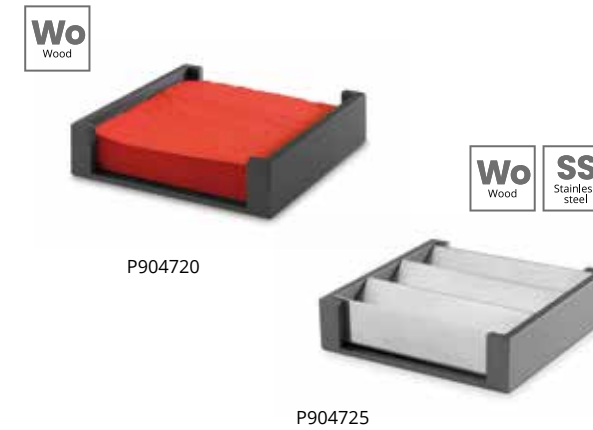

P904720

P904725

REF	W x D x H cm	€/u	
P904720	22 x 22 x 5,5	55,60	1
P904725	22 x 22 x 5,5	83,25	1

P904721 Tea & sugar bag holder
Soporte bolsas te y azúcar
Support pour saquettes de thé & sucre



For / Para / Pour ref. P904.720

REF	W x D x H cm	€/u	
P904721	19,8 x 19,8 x 4,9	32,20	1

P904850 1/1 GN wooden table + cutting board
Mesita buffet GN 1/1 + taco madera
Table GN 1/1 en bois + planche à découper



REF	W x D x H cm	€/u	
P904850	53 x 32,5 x 12	165,40	1

P904810 Low wooden table + cutting board
Mesita buffet baja + taco madera
Table basse en bois + planche à découper



REF	W x D x H cm	€/u	
P904810	32,5 x 22 x 12	130,35	1
P904820	32,5 x 22 x 16,5	145,10	1

P904804 Cutting board for wooden table
Taco madera para mesita buffet
Planche à découper pour table en bois



P904804

P904809

REF	W x D x H cm	€/u	
P904804 ¹	29,2 x 18,7 x 22	38,70	1
P904809 ²	49,7 x 29,2 x 22	52,30	1

(1) For / Para / Pour P904810 / P904820
(2) For / Para / Pour P904850

P20072 Methacrylate holder
Portamenús metacrilato
Porte-menus méthacrylate



REF	cm	€/u	
P20072	6 x 6	7,75	1



See products on / Ver productos en / Voir produits en page

P. 485

Stainless steel plate covers
Tapas Acero inoxidable para platos
Inox couvercles à assiette





ROOM SERVICE

P904780 Cutlery-holder tray
Bandeja porta-cubiertos
Plateau porte-couverts



GN 1/1



Stackables.
Apilables.
Empilables.

4 compartments
4 compartimentos
4 compartiments
303 x 115 mm

REF	W x D x H cm	€ / u	
P904780	53,9 x 33,5 x 7,7	147,00	1

P904760 Serving tray
Bandeja servicio y presentación
Plateau service et présentation



Stackables.
Apilables.
Empilables.

IDEA! Room service tray.
Perfecta para servicio de habitaciones.
Plateau idéal pour service de chambre.

REF	W x D x H cm	€ / u	
P904760	60 x 40 x 6,5	124,95	1

P904740 Serving tray
Bandeja presentación
Plateau présentation



Stackables.
Apilables.
Empilables.

REF	W x D x H cm	€ / u	
P904740	40 x 40 x 6,5	101,85	1

P904711 1/1 GN serving tray
Bandeja servicio y presentación GN 1/1
Plateau service et présentation GN 1/1



GN 1/1

Stackables.
Apilables.
Empilables.

1/1 Gastronorm container not included.
No incluye cubeta gastronorm 1/1.
Bac gastronorme 1/1 non inclus.

REF	W x D x H cm	€ / u	
P904711	53,9 x 33,5 x 7,7	110,80	1

P904600 Wooden cube with lid
Cubo con tapa madera
Cube en bois avec couvercle

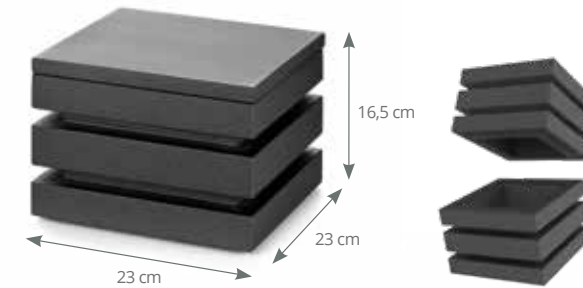

REF	€ / u	
P904600	120,35	1

P904650 Wooden narrow shelf
Estante madera estrecho
Tablette en bois étroite

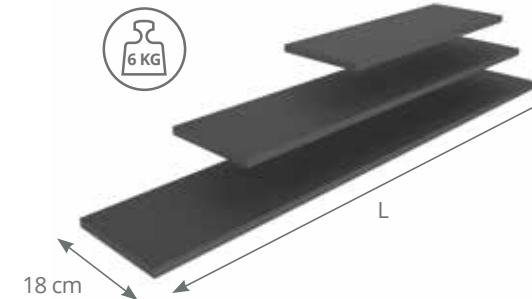

REF	L cm	€ / u	
P904650	50	41,05	1
P904680	80	50,25	1
P904610	100	51,90	1

P904937 Displayer for 4 melamine bowls
Presentador 4 bols melamina cuadrados
Présentoir 4 bols mélamine

For square bowls
Para bols cuadrados
Pour bols carrés
180 x 180
REF. P22.202



REF	W x D x H cm	€ / u	
P904937	37,5 x 50 x 1,5	85,15	1

P904950 Crossbar buffet trays
Travesaño soporte bandejas
Longerons pour plateaux buffet



P904660 Wooden lid
Tapa madera
Couvercle en bois



REF	€ / u	
P904660	19,75	1

P904652 Wooden wide shelf
Estante madera ancho
Tablette en bois large

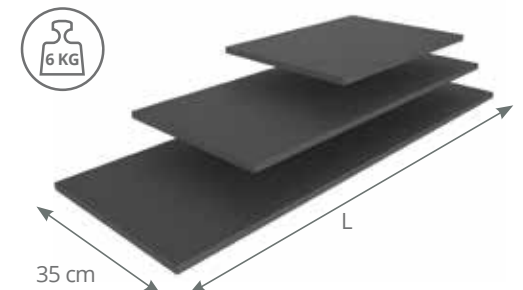

REF	L cm	€ / u	
P904652	50	68,70	1
P904682	80	89,15	1
P904612	100	92,10	1

P904975 Displayer for 6 melamine bowls
Presentador 6 bols melamina cuadrados
Présentoir 6 bols mélamine

For square bowls
Para bols cuadrados
Pour bols carrés
180 x 180
REF. P22.202



REF	W x D x H cm	€ / u	
P904975	75 x 50 x 1,5	100,30	1

REF	W x D x H cm	€ / u	
P904950	50 x 12,4 x 2	62,30	1
P904980	80 x 12,4 x 2	68,20	1
P904990	100 x 12,4 x 2	72,85	1

P904165 Perforated buffet display

Buffet perforado
Buffet perforé



Includes:
Wooden frame perforated 1/1 GN pan 65 mm gastronorm pan 1/1 20 mm roll-top lid.

Incluye:
Marco madera bandeja perforada GN 1/1 65 mm cubeta GN 1/1 20 mm cúpula roll-top

Inclus:
Cadre en bois bac GN 1/1 65 mm perforé bac GN 1/1 20 mm couvercle roll-top

REF	W x D x H cm	€ / u	
P904165	57 x 37 x 31	258,10	1

P904113 Triple buffet display

Buffet triple
Buffet triple



Includes:
Wooden frame 3 units 1/3 GN pans 65 mm GN pan 1/1 20 mm roll-top lid.

Incluye:
Marco madera 3 cubetas GN 1/3 65 mm cubeta GN 1/1 20 mm cúpula roll-top.

Inclus:
Cadre en bois 3 bacs GN 1/3 65 mm bac GN 1/1 20 mm couvercle roll-top.

REF	W x D x H cm	€ / u	
P904113	57 x 37 x 31	257,25	1

P904200 Wooden frame

Marco madera
Cadre en bois



P904.200

P904120 Standard buffet display

Buffet estandar
Buffet standard



Includes:
Wooden frame 2u. 1/1 GN 1/1 20 mm roll-top lid

Incluye:
Marco madera 2 u. cubeta GN 1/1 20 mm cúpula roll-top

Inclus:
Cadre en bois 2 u. bacs GN 1/1 20 mm couvercle roll-top

REF	W x D x H cm	€ / u	
P904120	57 x 37 x 31	243,30	1

P904140 Cheese buffet display

Buffet quesos
Buffet fromage



Includes:
Wooden frame wooden cutting board GN pan 1/1 20 mm roll-top lid.

Incluye:
Marco madera bandeja corte madera cubeta GN 1/1 20 mm cúpula roll-top.

Inclus:
Cadre en bois planque à découper en bois bac GN 1/1 20 mm couvercle roll-top.

REF	W x D x H cm	€ / u	
P904140	57 x 37 x 31	287,00	1

REF	W x D x H cm	€ / u	
P904200	57 x 37 x 14,5	128,05	1

P904400 Isothermal mat

Tapete isotérmico
Tapis isotherme



REF	W x D x H cm	€ / u	
P904400	47 x 26 x 20	11,75	250

P904160 Melamine slate buffet displayer

Buffet pizarra melamina
Mélamine buffet ardoise



Includes:
Wooden frame melamine slate board 1/1 GN container 20 mm

Incluye:
Marco madera tabla pizarra melamina cubeta GN 1/1 20 mm

Inclus:
Cadre en bois plaque ardoise en mélamine bac GN 1/1 20 mm

REF	W x D x H cm	€ / u	
P904160	57 x 37 x 14,5	207,50	1

P904146 Wooden bread cutting board

Cortador pan madera
Plaque à découper pain en bois



REF	W x D x H cm	€ / u	
P904146	52 x 31,5 x 20	49,60	1

P904500 Cooling plate

Placa enfriadora
Plaque réfrigérante



- 12 °C



Adjustable to 1/1 GN pan.
Adaptable a cubeta GN 1/1.
Adaptable à bac GN 1/1.

REF	W x D x H cm	€ / u	
P904500	47,5 x 27,7 x 3	68,45	5

P904145 Bread buffet display

Buffet pan
Buffet pain



Includes:
Wooden frame bread cutting board 1/1 GN container 20 mm

Incluye:
Marco madera cortador pan madera cubeta GN 1/1 20 mm

Inclus:
Cadre en bois plaque à découper pain en bois bac GN 1/1 20 mm

REF	W x D x H cm	€ / u	
P904145	57 x 37 x 14,5	191,85	1

P904142 Wooden bread cutting board

Cortador pan madera
Plaque à découper pain en bois



GN 1/1

REF	W x D x H cm	€ / u	
P904142	53 x 32,5 x 2	85,05	1

EXCLUSIVE



BUFFET TROLLEY WITH POSSIBLE TRANSFORMATION FROM AN EXPOSITOR TROLLEY TO A PRESENTATION TABLE
CARRO BUFFET CON POSIBILIDAD DE CONVERTIR EL CARRO EXPOSITOR EN MESA DE PRESENTACIÓN
CHARIOT BUFFET AVEC POSSIBILITÉ DE CONVERTIR LE CHARIOT D'EXPOSITION EN UNE TABLE DE PRÉSENTATION



***Two cover are included on the price**
**Dos tapas incluidas en precio*
**Deux tablettes comprises dans le prix*
P90492

Cover for 1/1 GN insert not included on the price
Tapa individual encaje GN 1/1 no incluida en precio
Tablette de bac GN 1/1 non comprise dans le prix
P90493

P90490 Black buffet trolley for 4 1/1 GN inserts
Carro buffet negro 4 GN 1/1
Chariot buffet noir pour 4 bacs GN 1/1



REF	Type / Tipo	€/u	
P90490*	4 X GN 1/1	1.490,30	1
P90492	Tapa / Cover / Tablette	146,00	1
P90493	Tapa / Cover / Tablette 1/1	52,30	1

Outstanding combination of wood and aluminium
Elegante combinación de madera y aluminio
Combinaison élégante en bois et en aluminium



Wood with special waterproof treatment, easy to clean
Madera con tratamiento hidrófugo especial, de fácil limpieza
Bois avec un traitement hydrofuge spécial, facile à nettoyer

Reinforcement bar
Barra refuerzo nivel inferior
Barre de renforcement



Soundproof and revolving castors Ø 125 mm, with brakes
Ruedas giratorias e insonoras de Ø 125 mm, con freno
Roulettes insonores et pivotantes de Ø 125 mm, avec freins

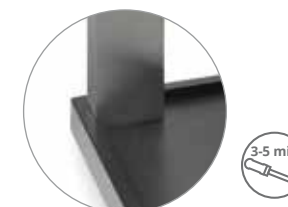

Delivered flatpacked between 3 to 5 minutes assembly
Se suministran desmontados entre 3 a 5 minutos de montaje
Livrés démontés entre 3 et 5 minutes de montage



Suitable for gastronorm sizes
Adaptado a medidas gastronorm
Adapté aux mesures gastronorme

TREND **Wooden-aluminium trolley 2 shelves**
Carro madera-aluminio 2 estanterías
Chariot en bois-aluminium 2 plateaux



REF	Colour	€/u	
P80220	Negro / Black / Noir	656,00	1

P80219 **Wooden gueridon trolley**
Gueridón o carro auxiliar madera
Chariot guéridon en bois



REF	Colour	€/u	
P80219	Negro / Black / Noir	534,25	1

P80216 **Oak melamine gueridon trolley**
Carro guerdón melamina roble
Chariot guéridon mélamine roure

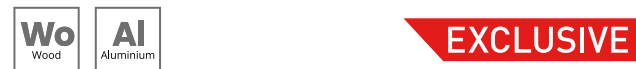

REF	€/u	
P80216	721,05	1

P90813 **Cutlery dispenser trolley**
Carro porta-cubiertos
Chariot porte couverts



Trays, dishes, GN containers and cutlery dispenser not included
No incluye porta-cubiertos, cubetas GN, platos ni bandejas
Ramasse-couverts, bacs GN, assiettes, et plateaux pas compris

REF	€/u	
P908132	1.110,45	1
P90813	1.026,60	1

P90814 **Cutlery bin**
Porta-cubiertos
Ramasse-couverts

EXCLUSIVE

4 x 1/3 GN
H max. 6,5 cm



GN containers not included
No incluye cubetas GN
Bacs GN non inclus

REF	W x D x H mm	€/u	
P908142	710 x 335 x 155	192,85	1
P90814	710 x 335 x 155	140,65	1

14.8 Chafers & dispensers

Chafings y dispensadores
Chafers et distributeurs



An elegant yet versatile chafers with a low profile design for the best food presentation.

Glass top version allows viewing of food without opening chafers - maintaining food quality.

Removable cover with baffle, "stay put" hinge design holds cover in closed, 45° or 90° position.

Reinforced bracket with rubber table feet for longer life and to keep chafers in place.

Dripless cover and pans keep condensation off of food and tabletop.

Available with mirror-finished stainless steel or porcelain food pans.

Un elegante y versátil chafers con un diseño de perfil bajo para una mejor presentación.

Modelo con parte superior de vidrio que permite ver la comida sin abrir el chafers - manteniendo la calidad del alimento.

Tapa removible con bisagra de cierre lento. Tres ángulos de apertura, cerrada, 45° ó 90°.

Soporte reforzado con piés antideslizantes que permite una mayor estabilidad.

La tapa y cubeta con sistema anti-goteo mantienen la condensación fuera del alimento.

Se presenta con cubetas de acero inoxidable brillante o de porcelana.

Un chafers élégant à la fois polyvalent et discret pour la meilleure présentation des plats.

Le modèle muni d'un couvercle en verre permet de voir le contenu sans ouvrir le chafers - tout en préservant la qualité des aliments.

Couvercle amovible équipé d'un déflecteur et d'une charnière bloquante qui permet de maintenir le couvercle fermé, à 45° ou à 90°.

Support renforcé avec des pieds de table en caoutchouc afin d'offrir une durée de vie plus longue et un meilleur maintien des chafers.

Le couvercle antigouttes et les bacs empêchent la condensation des aliments et de la table.

Disponibles avec bac à aliments en inox ultra-brillant ou en porcelaine.

4644010 Rectangular chafing dish with crystal lid
Chafing dish rectangular con tapa de cristal
Chauffe-plat rectangulaire avec couvercle en verre

SS Stainless steel
Cr Crystal
induction

NEW!



REF	W x D x H cm	€/u	
4644010	58,4 x 46,5 x 19,8	1.582,00	1

4644020 Square chafing dish with crystal lid
Chafing dish cuadrado con tapa de cristal
Chauffe-plat carré avec couvercle en verre

SS Stainless steel
Cr Crystal
induction

NEW!



REF	W x D x H cm	€/u	
4644020	46,4 x 46,4 x 17	1.381,00	1

Chafers & dispensers 14.8

Chafings y dispensadores
Chafers et distributeurs

46132 Square chafing dish
Chafing dish cuadrado
Chauffe-plat carré

SS Stainless steel
induction

NEW!



REF	W x D x H cm	€/u	
46132	39,2 x 41,3 x 20,3	1.195,00	1

46134 Glass top S/S chafers with S/S trim
Chafing dish cuadrado con tapa cristal
Chauffe-inox à couvercle en verre

SS Stainless steel
Cr Crystal
induction



REF	W x D x H cm	L	€/u	
46134	392 x 176 x 412	5,8	1.298,40	1

46124 Glass top S/S chafers with S/S trim
Chafing dish redondo con tapa cristal
Chauffe-inox à couvercle en verre

SS Stainless steel
Cr Crystal
induction

NEW!



Details in Golden colour.
Detalles en color dorado.
Détails en couleur dorée.

REF	Ø cm	H cm	L	€/u	
46124	39,4	8	5,8	987,00	1

46125 Glass top S/S chafers with S/S trim
Chafing dish redondo con tapa cristal
Chauffe-inox à couvercle en verre

SS Stainless steel
Cr Crystal
induction



REF	Ø cm	H cm	L	€/u	
46125	39,4	8	5,8	987,00	1

46131 Food pan
Fuente interior redonda
Bac à aliments

SS Stainless steel



REF	cm	L	€/u	
46131	39,4 x 7	5,6	176,00	1
46861	39,4 x 7	3,8	98,50	1 NEW

46137 Food pan
Fuente interior cuadrada
Bac à aliments

SS Stainless steel



REF	W x D x H cm	L	€/u	
46137	39,2 x 7,1 x 39,2	6,3	218,85	1

14.8 Chafers & dispensers

Chafings y dispensadores
Chafers et distributeurs



P3875 Rectangular chafing dish roll top lid
Chafing dish rectangular con tapa roll top
Chafing dish rectangulaire avec couvercle roll top



Stand, water pan, insert, lid and St/Steel handles.
With 2 burners.

Soporte, recipiente, cubeta, tapa y asas de chapa en acero inox.
Con 2 quemadores.

Support, récipient, bac, couvercle et poignées en acier inox.
Avec 2 brûleurs.

REF	W x D x H cm	L	€ / u	
P387500	74 x 45 x 41	9,0	412,80	1

P8975 Round chafing dish roll top lid
Chafing dish redondo tapa roll top
Chafing dish rond avec couvercle roll top

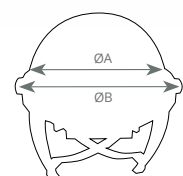

Max. opening: 180°.
Apertura máxima: 180°.
Ouverture maximale: 180°.

REF	ØA cm	ØB cm	H cm	€ / u	
P897500	35	51,5	48,5	368,65	1

Chafers & dispensers 14.8

Chafings y dispensadores
Chafers et distributeurs



46080 Oblong roll top chafer
Chafer apaisado con tapa roll top
Couvercle roll top rectangulaire chauffe-plat



NEW!

Stand, water pan, insert, lid and St/Steel handles.
With 2 burners.

Soporte, recipiente, cubeta, tapa y asas de chapa en acero inox.
Con 2 quemadores.

Support, récipient, bac, couvercle et poignées en acier inox.
Avec 2 brûleurs.

REF	W x D x H cm	€ / u	
46080	65,6 x 44,5 x 46,7	1.586,00	1

P387 Chafing dish with roll top lid
Chafing dish con tapa roll top
Chafing dish avec couvercle "roll top"



Stand, water pan, insert, lid and St/Steel handles.
With 2 burners.

Soporte, recipiente, cubeta, tapa y asas de chapa en acero inox.
Con 2 quemadores.

Support, récipient, bac, couvercle et poignées en acier inox.
Avec 2 brûleurs.

REF	W x D x H cm	L	€ / u	
P387065	65 x 38 x 39	9,5	309,95	1

P379 Chafing dish with lid
Chafing dish con tapa
Chafing dish avec couvercle



Stand, water pan, insert, lid and St/Steel handles.
With 2 burners.

Soporte, recipiente, cubeta, tapa y asas de chapa en acero inox.
Con 2 quemadores.

Support, récipient, bac, couvercle et poignées en acier inox.
Avec 2 brûleurs.

REF	W x D x H cm	L	€ / u	
P379065	65 x 35 x 34	9,5	244,80	1

46095 Gravy/sauce chafer
Chafer de salsas
Réchauffeur de sauce



NEW!

REF	W x D x H cm	€ / u	
46095	31,8 x 29,2 x 37,8	947,25	1

46070 Round roll top chafer
Chafer redondo con tapa roll top
Couvercle roll top chauffe-plat



NEW!

REF	W x D x H cm	€ / u	
46070	49,2 x 48 x 46,5	1.111,00	1

P3795 Economical chafing dish with lid
Chafing dish económico con tapa
Chafing dish économique avec couvercle



Stand, water pan, insert, lid and St/Steel handles.
With 2 burners.

Soporte, recipiente, cubeta, tapa y asas de chapa en acero inox.
Con 2 quemadores.

Support, récipient, bac, couvercle et poignées en acier inox.
Avec 2 brûleurs.

REF	W x D x H cm	L	€ / u	
P379500	65 x 35 x 32	9	125,80	1

14.8 Chafers & dispensers

Chafings y dispensadores
Chafers et distributeurs

P950000 Electric heating unit for chafing dish
Elemento eléctrico para chafing dish
Corps de chauffe pour chafing dish



For / Para / Pour:
P387500, P897500, P387065, P379065, P379500

REF	W	€ / u	
P950000	240	214,60	1

P962 Hot tray warmer
Calentador de platos o bandejas
Réchaud



P3722 Burner holder for chafing dish
Contenedor para combustible de chafing dish
Porte-brûleur pour chafing dish



Adaptable. REF:
P379, P387, P898, P8991

REF	€ / u	
P372200	10,00	24

P3871 Chafing dish fuel
P3872 Fuel para chafing dish
Fuel pour chafing dish



REF	cm	Lenght / Duración / Durée	€ / u	
P387100	65 x 55	3 h	2,45	75
P387200	83 x 60	6 h	4,60	60

46110 Universal electric chafer heater
Elemento eléctrico universal para chafing dish
Résistance électrique pour chafers

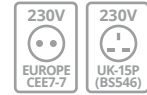

Sized to fit standard fuel opening.
Dimensiones compatibles con el orificio para combustible estándar.
Dimensions compatibles avec l'orifice pour combustible standard.

REF	For / Para	V	W	A	Ench. Plug	€ / u	
46110	EU	230	120/230	1.0	EU	378,20	1
46115	UK	230	120/230	1.0	UK	378,20	1

REF	Burners / Quemadores / Brûleurs	W x D x H cm	€ / u	
P962002	2	370 x 175 x 70	57,80	10
P962003	3	430 x 175 x 70	90,20	10

St/Steel with aluminium cover plate.
Inox con placa base de aluminio.
Inox avec plaque couvercle en aluminium.

2 or 3 burners.
2 ó 3 quemadores.
2 ou 3 brûleurs.

P685 Chafing dish fuel barrel
Fuel para chafing dish
Bidón fuel chafing dish



No soot. No smell
Sin hollín. Sin olor
Pas de suie. Inodore

REF	L	KG	€ / u	
P685004	5	5	37,75	3

Thanks to its special formula no storage or transport restriction are involved. Resealable. Non spill - Non drip. Non flammable. Non combustible. Non toxic fuel. Easy open & close. Container does not become hot to touch. Does not evaporate if left uncapped.

Gracias a su fórmula especial no hay ninguna restricción especial por almacenaje o transporte. No gotea ni se derrama. No se evapora si se deja abierto. Puede guardarse si no se consume todo. No inflamable. No tóxico. Fácil de abrir y cerrar. La lata no se calienta. Fácil de encender una vez apagada.

Grâce à sa formule spéciale il n'y pas de restriction pour le stockage et le transport. Hermétique. Non inflammable. Non combustible. Non toxique. Facile à ouvrir et fermer. On peut le garder si on ne le consomme pas tout. Facile à allumer une fois éteint.

Chafers & dispensers 14.8

Chafings y dispensadores
Chafers et distributeurs



P903 Cooling plate
Placa enfriadora
Plaque réfrigérante



REF	Type / Tipo	cm	€ / u	
P903001	1/1	53 x 32,5	204,35	4
P903002	1/2	32,5 x 26,5	140,45	6

For an easy and hygienic presentation of cold food. Simple place in the freezer. Minimum 4 hour under -4°C. Tolerance under 23°C: 5-6h.

Para una presentación fácil e higiénica de alimentos fríos en los buffets. En el congelador: Mínimo 4h por debajo de los -4 °C. Aguanta 5-6h con temperaturas por debajo de los 23 °C.

Pour une présentation hygienique et facile des aliments froids sur les buffets. Au congélateur. Minimum 4h à des températures inférieures à -4 °C. Résistance à des températures inférieures à 23 °C: 5-6h.

78710 Bain maries
Baño maría
Bain-marie



REF	Ø cm	H cm	L	€ / u	
78710	10,5	14,5	1,20	31,15	6
78720	12,5	17,0	1,90	39,70	6
78725	15,5	10,0	1,90	39,70	6
78730	15,5	18,5	3,30	42,65	6
78740	16,5	19,5	4,00	46,75	6
78760	18,5	22,0	5,70	58,95	6

14.8 Chafers & dispensers

Chafings y dispensadores
Chafers et distributeurs



4609 Coffee urn
Urna de café
Boîte à café

NEW!

SS
Stainless steel



46093 46094

REF	W x D x H cm	€ / u	
46093	31,6 x 34,3 x 50,3	1.145,00	1
46094	39,4 x 41,8 x 54,5	1.480,00	1

46285 Cold beverage server
Dispensador de bebidas frías
Distributeur boisson froide

NEW!

SS PC
Stainless steel Polycarbonate



REF	W x D x H cm	€ / u	
46285	20,3 x 28 x 53,3	788,50	1

4635810 Somerville cold beverage server
Dispensador de bebidas frías-Somerville
Distributeur de boisson froide Somerville

NEW!

SS PC
Stainless steel Polycarbonate



REF	W x D x H cm	€ / u	
4635810	24,6 x 29 x 64	1.147,00	1

4635110 Somerville milk dispenser
Dispensador de leche-Somerville
Distributeur de lait Somerville

NEW!

SS
Stainless steel



REF	W x D x H cm	€ / u	
4635110	20,3 x 32,7 x 41,4	1.342,10	1

Chafers & dispensers 14.8

Chafings y dispensadores
Chafers et distributeurs

P8992 Juice dispenser St/Steel
Dispensador de zumos - acero inox
Distributeur à jus - acier inox

SS PC
Stainless steel Polycarbonate



REF	L	€ / u	
P899200	8	276,70	1

P8993 St/Steel milk dispenser
Dispensador de leche - acero inox
Distributeur à lait - acier inox

SS
Stainless steel



REF	L	€ / u	
P899300	8	301,85	1

4635210 Double Cereal Dispenser
Dispensador de cereales doble
Distributeur à céréales double

SS PC
Stainless steel Polycarbonate



REF	W x D x H cm	L (x2)	€ / u	
4635210	31 x 22 x 60	3,8	879,10	1

T3660 D-Lux cereal dispenser
Dispensador de cereales D-Lux
Distributeur à céréales D-Lux

SS Ac
Stainless steel Acrylic



REF	W x D x H cm	L	€ / u	
T3660	25,4 x 35,6 x 68,6	8	471,15	1

BUFFET & ACCESSOIRES
BUFFET Y ACCESORIOS
BUFFET ET ACCESSOIRES

BUFFET & ACCESSOIRES
BUFFET Y ACCESORIOS
BUFFET ET ACCESSOIRES

14.9 Bowls & serving trays

Bols & bandejas de servicio
Bols & plateaux

18/10
Stainless steel

Double wall insulated serving bowls that allows keeping the food temperature, whether cold or hot.

Construcción aislante de pared doble que permite conservar la temperatura de los alimentos, ya sean fríos o calientes.

Construction d'isolation à double paroi qui permet de maintenir la température de la nourriture, froide ou chaude.



Will not TRANSPIRE. Requires no preheating or chilling
No transpiran. No es necesario precalentar o enfriar
Pas de condensation sur les parois. N'exige aucun préchauffage ou refroidissement

Insulating walls that keep food at service temperature
Paredes aislantes que mantienen los alimentos a la temperatura de servicio
Construction isolant qui garde les aliments à la température de service

HAND WASHING
LAVAR A MANO
HAND WASHING

COLD RETENTION: Double wall insulated bowls TEST PROTOCOL, 2004
RETENCIÓN DEL FRÍO: Bols aislantes de doble pared PROTOCOLO DE PRUEBA, 2004
RÉTENTION DU FROIDE: Construction d'isolation à double paroi PROTOCOLE D'ESSAI, 2004

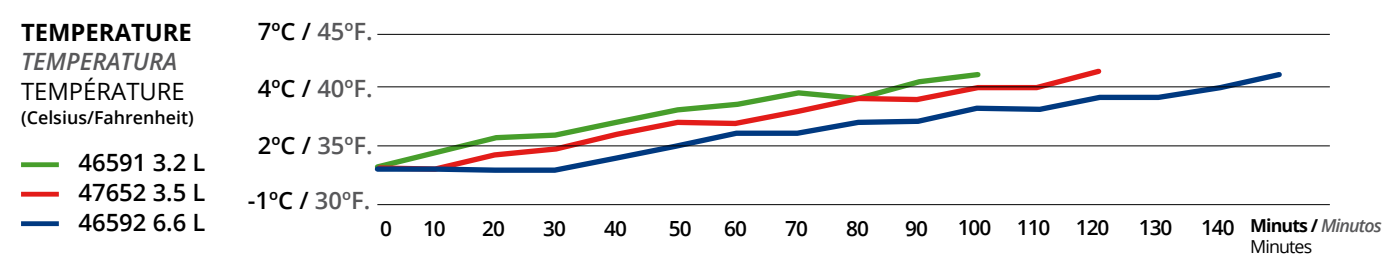

- Potato salad was placed in different bowls. Filling ¾ of the capacity of the bowl.
- Initial temperature of the food 0,6°C; ambient temperature 20,6°C.
- The temperature in the centre of the salad was recorded every 10 minutes.
- The test concluded when the food reached a temperature of 5°C.

Bowls & serving trays 14.9

Bols & bandejas de servicio
Bols & plateaux

18/10
Stainless steel

46590 Round colored double wall bowls
Bol colores redondo doble pared
Bols ronds de service à double paroi isothermes en couleurs



REF	Ø cm	H cm	L	€/u	☐
46590 + COLOR	18,4	10,3	1,6	69,85	6
46591 + COLOR	24,1	12,9	3,2	104,95	6
46592 + COLOR	30,0	16,5	6,6	148,00	3

47632 Square colored double wall bowls
Bol colores cuadrado doble pared
Bols carrés de service à double paroi isothermes en couleurs



REF	cm	H cm	L	€/u	☐
47632 + COLOR	18,4 x 18,4	8,7	1,7	71,65	12
47634 + COLOR	21,6 x 21,6	10,8	3,0	94,85	6
47635 + COLOR	25,8 x 25,8	13,0	4,9	122,05	4

46584 Angled beehive bowls
Bol inclinado doble pared
Bols nid d'abeilles à paroi inclinée



REF	Ø cm	H cm	L	€/u	☐
46584	18,8	13,9	0,95	45,60	6
46585	24,0	17,3	1,7	71,85	6
46586	30,0	20,9	3,5	104,75	2
46582	35,0	23,9	4,7	160,85	2

47619 Double-wall square beehive serving bowls
Bol estriado cuadrado doble pared
Bol lis carré double paroi



REF	W x D x H cm	L	€/u	☐
47619	13,9 x 13,9 x 7	0,7	39,40	6
47632	18,5 x 18,5 x 8,9	1,7	49,55	12
47634	21,8 x 21,8 x 10,8	3,0	67,65	6
47635	24,4 x 24,4 x 13,1	4,9	91,15	4
47637	29,9 x 29,9 x 15	7,8	121,85	3

46587 Beehive style double-wall serving bowls
Bol estridado redondo doble pared
Bol à bande rond double paroi



Mirror finished
Acero inoxidable brillante
Polissage brillant

REF	Ø cm	H cm	L	€/u	☐
46587	14,4	7,6	0,7	32,25	6
46590	18,4	10,3	1,6	48,90	6
46591	24,1	12,9	3,2	77,45	6
46592	30,0	16,5	6,6	113,65	3
46569	35,0	17,5	9,6	161,75	2

46665 Beehive style double-wall serving bowls
Bol redondo doble pared con aro brillante
Bol bande brillant rond double paroi



Body mat finished.
Rim mirror finished.
Cuerpo pulido satinado.
Borde superior pulido brillante.
Finition corps satinée.
Finition bande brillante.

REF	Ø cm	H cm	L	€/u	☐
46665	14,4	7,6	0,7	32,25	6
46666	18,4	10,3	1,6	48,45	6
46667	24,1	12,9	3,2	76,55	6

14.9 Bowls & serving trays

Bols & bandejas de servicio
Bols & plateaux

18/10
Stainless
steel

Satin-finished rim and mirror-finished interior creates a visual contrast that accentuates the food product

Borde con acabado satinado e interior brillante, creando una elegante contraste visual

Le rebord satiné et l'intérieur ultra-brillant crée un contraste visuel qui met en valeur les plats

82093 Rectangular Stainless Steel serving trays
Bandeja servicio rectangular acero inoxidable
Plateau service rectangulaire



REF	cm	€/u	
82093	30,5 x 22,9	46,20	3
82094	45,7 x 25,4	67,80	3
82095	53,3 x 30,5	89,40	3

46221 Curved tray
Bandeja curva
Plateau incurvé



REF	cm	€/u	
46221	19,1 x 19,1	40,90	1



P3174 Economical oval serving dish with rolled edge
Fuente oval borde vuelto económica
Plat ovale à bords ronds économique

Mirror finished
Pulido brillante
Polissage brillant



REF	cm	€/u	
P317425	25 x 17,5	7,75	60
P317430	30 x 21,0	8,70	60
P317435	35 x 24,0	10,35	60
P317440	40 x 26,5	11,40	40
P317445	45 x 29,5	13,90	30
P317450	50 x 34,0	17,75	24

P317 Oval serving dish with rolled edge
Fuente oval borde vuelto
Plat ovale à bords ronds

Satin finished
Pulido satinado
Polissage satiné



REF	cm	€/u	
P317025	25 x 17,2	10,75	1
P317030	30 x 20,2	13,10	1
P317035	35 x 23,3	15,90	1
P317040	40 x 26,7	19,75	1
P317045	45 x 29,2	22,10	1
P317050	50 x 31,2	28,70	1

Bowls & serving trays 14.9

Bols & bandejas de servicio
Bols & plateaux

P907 St/Steel soup tureen with stand
Sopera inox con base
Soupière inox avec pied

SS
Stainless
steel

Mirror finished
Pulido brillante
Polissage brillant



REF	Ø cm	L	€/u	
P907024	24	2,50	18,40	6
P907026	26	3,50	21,00	6

P927 Acrylic round salad bowl
Ensaladera acrílica redonda
Saladier rond acrylique

Ac
Acrylic



REF	Ø cm	H cm	€/u	
P927000	25,8 x 15,8	15,8	33,00	6

P928 Acrylic Squared salad bowl
Ensaladera acrílica cuadrada
Saladier carré acrylique

Ac
Acrylic



P928000



P928001

REF	W x D x H cm	€/u	
P928000	28,5 x 28,5 x 12,4	17,00	12
P928001	14,7 x 14,7 x 7	3,65	48

See products on / Ver productos en / Voir produits en page

P. 388

Bandejas de servicio y buffet
Bandejas de servicio y buffet
Plateaux de service et de buffet





Serving tools 14.10

Utensilios de servicio
Ustensiles de service buffet

CLASSIC LINE



P361 One piece ladle
Cacillo monobloc
Louche monobloc



REF	Ø cm	L cm	L	€/u	📦
P361000	9	30	0,10	14,75	120

P362 One piece skimmer
Espumadera monobloc
Écumoire monobloc



REF	Ø cm	L cm	L	€/u	📦
P362000	11	33,5	10,40	13,90	120

P363 One piece turner
Espátula monobloc
Spatule monobloc



REF	L cm	€/u	📦
P363000	32	12,35	120

P364 One piece serving spoon
Cuchara de servicio monobloc
Cuillère de service monobloc



REF	L cm	€/u	📦
P364000	31	11,10	120

P365 One piece fork
Tenedor monobloc
Fourchette monobloc



REF	L cm	€/u	📦
P365000	32	10,00	120

P366 One piece sauce ladle
Cacillo salsas monobloc
Cuillère à sauces monobloc



REF	Ø cm	L cm	L	€/u	📦
P366000	7	28	0,10	13,25	120

P367 One piece salad spoon
Cuchara ensalada monobloc
Cuillère à salade monobloc



REF	L cm	€/u	📦
P367000	30	11,15	72

P368 Carving knife
Cuchillo cocina
Couteau à pâtisserie



REF	L cm	€/u	📦
P368000	28,5	8,45	240

P369 Cake server
Pala pasteles
Pelle à gâteau



REF	L cm	€/u	📦
P369000	22	9,05	120

14.10 Serving tools

Utensilios de servicio
Ustensiles de service buffet



ERGO LINE



Mirror polishing.
Pulido brillante.
Polissage brillant.

P3611 One piece ladle
Cacillo monobloc
Louche monobloc

REF	Ø cm	L cm	L	€/u	
P361100	9,5	32	0,15	10,60	48

P3621 One piece skimmer
Espumadera monobloc
Écumoire monobloc

REF	Ø cm	L cm	L	€/u	
P362100	11	35	7,15	9,60	48

P3631 One piece turner
Espátula monobloc
Spatule monobloc

REF	L cm	€/u	
P363100	37	9,05	48

P3641 One piece serving spoon
Cuchara de servicio monobloc
Cuillère de service monobloc

REF	L cm	€/u	
P364100	34,5	8,10	48

P3651 One piece fork
Tenedor monobloc
Fourchette monobloc

REF	L cm	€/u	
P365100	37	7,10	48

P3671 Spaghetti server
Cuchara para spaghetti
Cuillère à spaghetti

REF	L cm	€/u	
P367100	35	8,10	48

P3691 Cake server
Pala pasteles
Pelle à gâteau

REF	L cm	€/u	
P369100	31	7,25	48

Serving tools 14.10

Utensilios de servicio
Ustensiles de service buffet



COMET LINE



Mat satiny finished.
Pulido satinado mate.
Poli satiné mat.

P341 One piece ladle. 18% cr. St/Steel
Cacillo monobloc. Acero inox 18% cr.
Louche monobloc. inox 18% cr.

REF	Ø cm	L cm	L	€/u	
P341000	8,5	28	0,10	8,45	120

P342 One piece skimmer. 18% cr. St/Steel
Espumadera monobloc. inox 18% cr.
Écumoire monobloc. inox 18% cr.

REF	Ø cm	L cm	€/u	
P342000	11	33	8,35	120

P343 One piece turner. 18% cr. St/Steel
Espátula monobloc. inox 18% cr.
Spatule monobloc. inox 18% cr.

REF	L cm	€/u	
P343000	33	6,50	120

P344 One piece fork. 18% cr. St/Steel
Tenedor monobloc. inox 18% cr.
Fourchette monobloc. inox 18% cr.

REF	L cm	€/u	
P344000	30	6,25	120

P345 One piece spoon. 18% cr. St/Steel
Cuchara monobloc. inox 18% cr.
Cuillère monobloc. inox 18% cr.

REF	L cm	€/u	
P345000	34	6,60	120

48144 Steak knife black plastic handle
Cuchillo chuletero, mango plástico negro
Couteau Steak manche noir plastique

REF	Blade / Hoja / Lame L cm	Total L cm	€/u	
48144	12,4	25,1	51,55	12

48148 Steak knife riveted wooden handle
Cuchillo chuletero, mango plástico madera
Couteau Steak manche bois plastique

REF	Blade / Hoja / Lame L cm	Total L cm	€/u	
48148	12,7	25,1	39,00	12

14.10 Serving tools

Utensilios de servicio
Ustensiles de service buffet

SS
Stainless
steel

NEW!

46905 Ladle with one spout
Cacillo con un pico lateral
Louche avec bec latéral



REF	L cm	€ / u	
46905	28,71	13,75	12

46907 Ladle with one spout
Cacillo con un pico lateral
Louche avec bec latéral



REF	L cm	ml	€ / u	
46907	32	59,15	17,00	12

46909 Ladle
Cacillo
Louche



REF	L cm	€ / u	
46909	32	18,45	12

46936 Pastry server
Servidor de pasteles
Pelle de service



REF	L cm	€ / u	
46936	28	9,95	12

46952 Serving spoon
Cuchara de servicio
Cuillère de service



REF	L cm	€ / u	
46952	29,5	12,00	12

46960 Slotted serving spoon
Cuchara perforada para servir
Cuillère à fente de service



REF	L cm	€ / u	
46960	30,5	13,00	12

6440 Spoon
Cuchara
Cullière



REF	L cm	€ / u	
64403	33,60	15,20	12
64404	33,60	15,20	12
64406	39,37	18,55	12
64407	39,37	18,55	12

Serving tools 14.10

Utensilios de servicio
Ustensiles de service buffet

SS
Stainless
steel

Ny
Nylon



dishwasher
-40°C +210°C

P33621 Ladle
Cacillo
Louche



REF	L cm	Lts	€ / u	
P33621	35	0,08	7,80	1

P33622 Serving spoon
Cuchara de servicio
Cuillère de service



REF	L cm	€ / u	
P33622	35	7,80	1

P33623 Slotted spoon
Cuchara perforada
Cuillère à fente



REF	L cm	€ / u	
P33623	35	7,80	1

P33624 Turner
Espátula
Patule



REF	L cm	€ / u	
P33624	35	7,80	1

P33625 Spaghetti server
Cuchara para spaghetti
Cuillère à spaghetti



REF	L cm	€ / u	
P33625	35	7,80	1

14.10 Serving tools

Utensilios de servicio
Ustensiles de service buffet



dishwasher

P33801 Serving spoon
Cuchara de servicio
Cuillère de service



REF	L cm	€ / u	Icon
P33801	30,5	5,15	1

P33802 Slotted spoon
Cuchara perforada
Cuillère à fente



REF	L cm	€ / u	Icon
P33802	30,5	5,80	1

P33803 Turner
Espátula
Spatule



REF	L cm	€ / u	Icon
P33803	30,5	5,15	1

P33804 Spaghetti server
Cuchara para spaghetti
Cuillère à spaghetti



REF	L cm	€ / u	Icon
P33804	30,5	5,80	1

P33805 One piece fork
Tenedor de mesa
Fourchette



REF	L cm	€ / u	Icon
P33805	30,5	5,15	1

P33806 Serving tong
Pinza de servicio
Pince de service



REF	L cm	€ / u	Icon
P33806	28	7,15	1

P33807 Bread spoon
Pinza de pan
Pince à pain



REF	L cm	€ / u	Icon
P33807	25,5	7,15	1

P33808 Salad hands
Servidor de ensalada
Serveur salade



REF	L cm	€ / u	Icon
P33808	17,5	7,75	1

Pack: 2 u.

P33809 Knife
Cuchillo
Couteau



REF	L cm	€ / u	Icon
P33809	17,5	1,90	1

Serving tools 14.10

Utensilios de servicio
Ustensiles de service buffet



P358 Coloured BPA Free utility tong
Pinza buffet BPA Free color
Pince buffet SANS BPA en couleurs



REF 358 + L + COLOR



REF	L cm	Clear Transp.	White Blanco Blanc	Red Rojo Rouge	Black Negro Noir	€ / u	Icon
P358	23	0	1	2	7	4,10	1

46938 Buffet tong
Pinza buffet
Pince à buffet



REF	L cm	€ / u	Icon
46938	30,5	15,05	6

46926 Serving tong
Pinza servicio
Pince de service

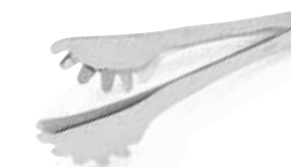

REF	L cm	€ / u	Icon
46926	21	13,20	12

4698 Spaghetti tong
Pinza espagueti
Pince à spaghetti

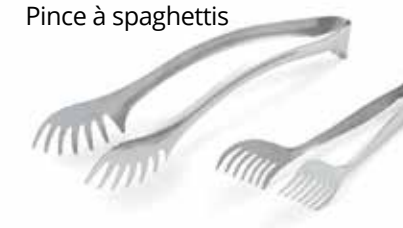

REF	L cm	€ / u	Icon
46988	23,0	19,95	12
46989	29,2	29,00	12

14.10 Serving tools

Utensilios de servicio
Ustensiles de service buffet



P359 Serving tong
Pinza de servicio
Pince de service



REF	L cm	€/ u	
P359000	24	9,60	1

P353 Salad tong
Pinza ensalada
Pince à salade



REF	L cm	€/ u	
P353000	26,5	20,60	120

46928 Bread tong
Pinza pan
Pince à pain



REF	L cm	€/ u	
46928	23,5	15,60	12

P606 Bread tong
Pinza pan
Pince à pain



REF	L cm	€/ u	
P606000	25	22,10	72

P605 Pasta tong
Pinza pasta
Pince à pâtes



REF	L cm	€/ u	
P605000	24	6,00	120

P351 Spaghetti tong
Pinza spaghetti
Pince à spaghetti



REF	L cm	€/ u	
P351000	19	4,25	120

P352 Cake tong
Pinza repostería
Pince à gâteau



REF	L cm	€/ u	
P352000	18	11,15	120

P617 Tong with ring
Pinza anillas
Tong with ring



REF	L cm	€/ u	
P617017	17	6,90	100

Serving tools 14.10

Utensilios de servicio
Ustensiles de service buffet



P618 Burger tong
Pinza hamburguesa
Pince à "burger"



REF	L cm	€/ u	
P618000	24	13,25	1

46929 Pastry tong
Pinza pastelería
Pince à pâtisserie



REF	L cm	€/ u	
46929	20	9,20	24



P615 Nut cracker
Cascanueces
Casse-noix



REF	L cm	€/ u	
P615000	16,5	8,50	120

P902 Butcher's tong
Pinza charcutería
Pince à charcuterie



REF	L cm	€/ u	
P902000	10,5 x 5	8,05	1

P389 Aluminium lobster cracker
Pinza para mariscos en aluminio
Casse-pattes en aluminium



REF	L cm	€/ u	
P389000	14	4,85	144

14.11 Signs

Señalización
Signalization

P19117 Barrier with retractable belt

Poste con cinta retráctil
Poteau dérouleur à sangle

SS
Stainless steel
Pintado negro
Black-painted
Peint noir



REF	H cm	Kg	€/ u	📦
P19117	90	7	77,30	2

P19114 Barrier with retractable belt

Poste con cinta retráctil
Poteau dérouleur à sangle

SS
Stainless steel

Mirror Polished.
Pulido brillante.
Polissage brillant.

Detachable head.
Cabezal removible.
Tête amovible.



REF	Colour / Color / Couleur	H cm	L cm	Kg	€/ u	📦
P19114N	●	94	200	9	102,30	1
P19114A	●	94	200	9	102,30	1
P19114R	●	94	200	9	102,30	1

P19118 Information sign

Panel información
Panneau information

SS
Stainless steel

For barrier
Para poste
Pour poteau
P19.117



REF	cm	€/ u	📦
P19118	22 x 46	49,55	10

P19115 Spare head

Recambio cabezal
Rechange de sangle

SS
Stainless steel

For barrier
Para poste
Pour poteau
P19.114



REF	Colour / Color / Couleur	L cm	€/ u	📦
P19115N	●	200	48,10	12
P19115A	●	200	48,10	12
P19115R	●	200	48,10	12

P19116 Information sign

Panel información
Panneau information

SS
Stainless steel

For barrier
Para poste
Pour poteau
P19.114



REF	cm	€/ u	📦
P19116	21,8 x 32	54,30	10

P19100 St/Steel barrier

Poste separación acero inoxidable
Poteau acier inoxydable

SS
Stainless steel

P19100
Mirror Polished.
Pulido brillante.
Polissage brillant.

P19101
Golden coated.
Baño dorado.
Doré.

Belt not included
Cordón no incluido
Cordon non inclus

Ref. P19100

Ref. P19101



REF	H cm	Kg	€/ u	📦
P19100	95	10,5	93,85	2
P19101	100	10,5	104,75	2

P19105 Belt with chromium-plated ends

Cordón con ganchos cromados
Cordon à crochets chromés

Te
Textile

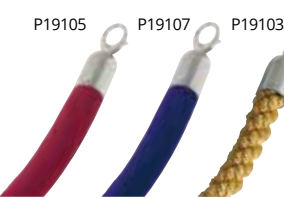

REF	Colour / Color / Couleur	L cm	€/ u	📦
P19105	●	150	23,00	18
P19107	●	150	23,00	18
P19103	●	150	46,00	18

P19106 Belt with golden ends

Cordón con ganchos dorados
Cordon à crochets dorés

Te
Textile



REF	Colour / Color / Couleur	L cm	€/ u	📦
P19106	●	150	23,00	18
P19104	●	150	49,35	18

Signs 14.11

Señalización
Signalization

Produced from special plastic completely anti-scratch material. Solid wood frame double-lacquered. Rain and sunproof. Writing-surfaces specially designed for using water based chalkmarkers.

Fabricadas con un material plástico especial que no se raya. Marcos de madera resistentes al agua y al sol. Pizarras especialmente diseñadas para el uso de tizas o rotuladores con base de agua.

Fabriqués avec un matériel plastique spécial anti-rayures. Cadres en bois massif. Résistants à la pluie et au soleil. Tableaux spécialement conçus pour l'utilisation des craies ou marqueurs avec base à eau.

P21000 / P21001 Caballete - Duo

Wo
Wood

PI
Plastic



REF	W cm	H cm	€/ u	📦
P21000	75	135	225,50	1
P21001	55	85	148,00	1

P21003 Caballete - Uno

Wo
Wood

PI
Plastic



REF	W cm	H cm	€/ u	📦
P21003	55	85	79,80	1

P2100 Universal

Wo
Wood

PI
Plastic



REF	W cm	H cm	€/ u	📦
P21005	50	60	34,90	5

P2101 Lucky

Wo
Wood

PI
Plastic

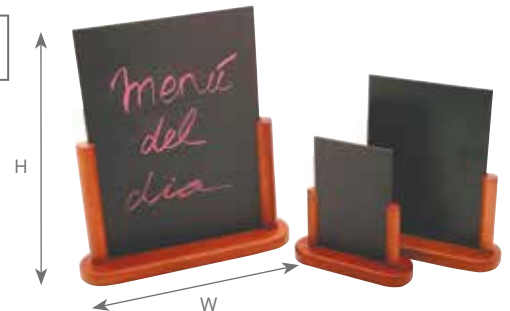

REF	W cm	H cm	€/ u	📦
P21015	10	15	9,60	36
P21016	15	21	11,40	24
P21017	21	30	19,00	10

P2102 Basic

PI
Plastic

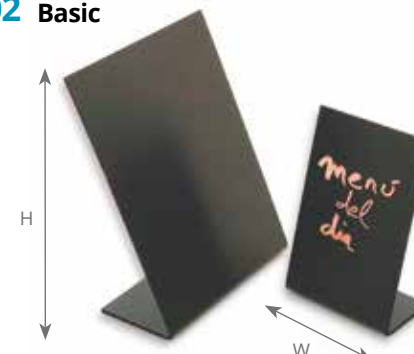

REF	W cm	H cm	€/ u	📦
P21027	10	15	6,70	200
P21028	15	23	11,25	100

P21020-26 Chalkmarker

Marcador tiza
Marqueur

PI
Plastic



Widths 2-6 mm
Grueso 2-6 mm
Épaisseur 2-6 mm

REF	Colour / Color / Couleur	€/ u	📦
P21020	White / Blanco / Blanc	6,75	500

15 Table service

Servicio de mesa
Arts de table



15.1 MINIATURES 454

MINIATURAS / MINIATURES

Stainless steel / Acero inoxidable / Acier inoxidable	454
Enamelled steel / Acero esmaltado / Acier émaillé	458
Cast aluminium / Aluminio de fundición / Fonte d'aluminium	459
Cast iron / Hierro fundido / Fonte émaillée	460

15.2 TABLE PRESENTATION 462

PRESENTACIÓN DE MESA / PRÉSENTATION TABLE

Wood / Madera / Bois	462
Taco and sandwich tray / Tacos y bocadillos presentación Présentation de Tacos et sandwichs	463
Tin plates display / Llaunas presentación / Plateaux inox présentation	464
Slates / Pizarras / Ardoises	466
Natural bamboo / Bambú natural / Bambou naturel	468
Baskets and breadbaskets / Paneras y cestas / Paniers et corbeilles	470
Place mats / Manteles individuales / Sets de table	478

15.3 TABLE SERVICE 479

SERVICIO DE MESA / SERVICE DE TABLE

Flared sauce cups / Salseras / Saucières	479
Table accessories / Complementos de mesa / Accessoires de table	480
Menu holders / Portamenús / Porte-menus	484
Food & table service / Servicio de mesa / Arts de table	485

15.1 Stainless steel miniatures

Miniaturas acero inoxidable
Miniatures acier inoxydable

SS
Stainless
steel



P24714 Mini round frying pan

Mini sartén redonda
Mini poêle ronde

NEW!



REF	Ø cm	H cm	€/u	6
P24714	12,0	3,5	15,20	6
P24715	15,5	4,5	18,25	6

P24716 Mini round saucepan

Mini cazo redondo
Mini casserole ronde

NEW!



REF	Ø cm	H cm	€/u	6
P24716	10,5	5	16,15	6
P24717	12,0	6	19,35	6

P24718 Mini square frying pan

Mini sartén cuadrada
Mini poêle carrée

NEW!



REF	W x D x H cm	€/u	6
P24718	12 x 12 x 3,5	18,35	6
P24719	14 x 14 x 3,5	21,55	6

Stainless steel miniatures 15.1

Miniaturas acero inoxidable
Miniatures acier inoxydable

SS
Stainless
steel

P24706 Mini saucepan

Mini cazo
Mini casserole

NEW!



REF	Ø cm	H cm	€/u	6
P24706	7	4,5	4,75	12
P24707	9	5,0	6,50	6

P24711 Mini saucepan. Copper color

Mini cazo. Color cobre
Mini casserole. Couleur cuivre

NEW!



REF	Ø cm	H cm	€/u	6
P24711	7	4,5	7,05	12
P24712	9	5,0	9,00	6

P24708 Mini wok

Mini wok
Mini wok

NEW!



REF	Ø cm	H cm	€/u	6
P24708	10	3	3,50	6

P24713 Mini wok. Copper color

Mini wok. Color cobre
Mini wok. Couleur cuivre

NEW!



REF	Ø cm	H cm	€/u	6
P24713	10	3	6,45	6

P24704 Mini frying pan

Mini sartén
Mini poêle

NEW!



REF	Ø cm	H cm	€/u	6
P24704	11	3,0	6,40	6
P24705	12	3,5	7,30	6

P24709 Mini frying pan. Copper color

Mini sartén. Color cobre
Mini poêle. Couleur cuivre

NEW!



REF	Ø cm	H cm	€/u	6
P24709	11	3,0	9,45	6
P24710	12	3,5	10,40	6

15.1 Stainless steel miniatures

Miniaturas acero inoxidable
Miniatures acier inoxydable



P24410 Mini rectangular roasting pan
Mini rustidera rectangular
Mini rôtissoire rectangulaire

NEW!



REF	W x D x H cm	€ / u	
P24410	14,5 x 9,5 x 7,5	6,05	12

P24411 Mini square roasting pan
Mini rustidera cuadrada
Mini rôtissoire carrée

NEW!



REF	W x D x H cm	€ / u	
P24411	11,5 x 11,5 x 7,5	5,50	12

P2440 Mini bucket
Mini cubo
Mini seau



REF	Ø cm	H cm	L	€ / u	
P24407	7,5	6,5	0,15	3,45	72
P24409	9,0	8,5	0,32	4,85	72

Stainless steel miniatures 15.1

Miniaturas acero inoxidable
Miniatures acier inoxydable



P24415 Serving cup
Vaso para servir
Tasse de service



NEW!



REF	Ø cm	H cm	€ / u	
P24415	8,5	8,5	3,30	12

P24412 Hammered serving cup
Vaso para servir hammered
Tasse de service martelée



NEW!



REF	Ø cm	H cm	€ / u	
P24412	8,5	8,5	4,10	12

P24413 Hammered serving cup. Copper color
Vaso para servir hammered. Color cobre
Tasse de service martelée Couleur cuivre



dishwasher

NEW!



REF	Ø cm	H cm	€ / u	
P24413	8,5	8,5	6,80	12

P24414 Hammered serving cup. Black color
Vaso para servir hammered. Color negro
Tasse de service martelée Couleur noire



dishwasher

NEW!



REF	Ø cm	H cm	€ / u	
P24414	8,5	8,5	6,80	12

15.1 Enamelled steel miniatures

Miniaturas acero esmaltado
Miniatures acier émaillé

ES
Enamelled
steel

P99801 Casserole with lid Cazuela con tapa Cocotte avec couvercle



NEW!



REF	Ø cm	H cm	€/ u	
P998010	10	6,0	14,95	1
P998012	12	4,0	17,45	1
P998014	14	4,5	19,90	1

P99901 Shallow casserole without lid Cazuela baja sin tapa Cocotte sans couvercle



NEW!



REF	Ø cm	H cm	€/ u	
P999012	12	6,5	9,95	1
P999014	14	7,0	11,95	1

P995 Enamelled steel paella pan Paellera acero esmaltado Plat à paella acier émaillé



REF	Ø cm	€/ u	
P995010	10	5,65	1
P995016	15	6,65	1

P997 Deep enamelled fry pan with handles Sartén honda esmaltada con asas Poêle haute avec anses



REF	Ø cm	Lts	€/ u	
P997014	14	0,4	6,00	1
P997016	16	0,5	6,50	1

Cast aluminium miniatures 15.1

Miniaturas aluminio de fundición
Miniatures fonte d'aluminium

CA
Cast
Aluminium

Made of cast aluminium with high resistance to deformation and excellent thermal performance.

Non-stick interior coating.

Fabricada en aluminio de fundición de gran resistencia a la deformación y con excelentes prestaciones térmicas.

Revestimiento interior antiadherente.

Fabriqué en fonte d'aluminium très résistante à la déformation et doté d'excellentes performances techniques.

Revêtement intérieur antiadhésif.

P151100 Mini black casserole with lid Mini cazuela negra con tapa Mini cocotte noire avec couvercle



NEW!

Wooden base included
Base de madera incluida.
Base en bois incluse



REF	Ø cm	H cm	€/ u	
P151100	10	5	21,55	1

P151200 Mini black oval casserole with lid Mini cazuela oval negra con tapa Mini cocotte ovale noire avec couvercle



NEW!

Wooden base included
Base de madera incluida.
Base en bois incluse



REF	W x D x H cm	€/ u	
P151200	13 x 10,5 x 5	22,95	1

P151300 Mini white casserole with lid Mini cazuela blanca con tapa Mini cocotte blanche avec couvercle



NEW!

Wooden base included
Base de madera incluida.
Base en bois incluse



REF	Ø cm	H cm	€/ u	
P151300	10	5	21,55	1

P151400 Mini white oval casserole with lid Mini cazuela oval blanca con tapa Mini cocotte ovale blanche avec couvercle



NEW!

Wooden base included
Base de madera incluida.
Base en bois incluse



REF	W x D x H cm	€/ u	
P151400	13 x 10,5 x 5	22,95	1

P141 Shallow casserole without lid Cazuela baja sin tapa Cocotte sans couvercle



REF	Ø cm	H cm	€/ u	
P141014	14	4,0	28,35	1
P141016	16	5,0	34,75	1
P141020	20	5,5	37,60	1

P151 Deep casserole without lid Cazuela alta sin tapa Braiseuse sans couvercle

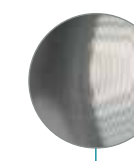

Ground base
Fondo torneado
Fond dressé



REF	Ø cm	H cm	€/ u	
P151012	12	8,5	30,00	1
P151014	14	8,5	36,75	1
P151016	16	8,0	38,15	1

15.1 Cast iron miniatures

Miniaturas hierro fundido
Miniatures fonte émaillée



Enamelled cast iron miniatures perfect for individual service and presentations.

Miniaturas en hierro fundido y esmaltado interior, perfectas para servicio individual y presentación.

Miniatures en fonte émaillée (à l'intérieur) idéales pour le service individuel et la présentation.



P23500 Mini fry pan
Mini sartén
Mini poêle ronde



REF	Ø cm	L cm	H cm	€/u	📦
P23500	10,5	16	2,6	6,60	12

P23501 Mini fry pan
Mini sartén
Mini poêle ronde



REF	Ø cm	L cm	H cm	€/u	📦
P23501	13,5	21	2,5	10,35	12

P23502 Mini deep fry pan
Mini sartén alta
Mini poêle ronde haute



REF	Ø cm	L cm	H cm	€/u	📦
P23502	14	23,5	3,8	15,50	12

P23503 Mini squared fry pan
Mini sartén cuadrada
Mini poêle carrée



REF	W x D x H cm	L cm	€/u	📦
P23503	13,6 x 13,6 x 3,6	23,3	16,75	12

Cast iron miniatures 15.1

Miniaturas hierro fundido
Miniatures fonte émaillée



P23504 Mini oblong fry pan
Mini sartén rectangular
Mini poêle rectangulaire



REF	W x D x H cm	L cm	€/u	📦
P23504	12,7 x 10,5 x 2,5	18	9,40	12

P23508 Oval casserole
Cacerola oval
Mini casserole ovale



REF	W x D x H cm	Lts	€/u	📦
P23508	21,5 x 15,5 x 6,5	0,60	25,30	8

P23505 Mini round casserole with lid
Mini cacerola con tapa
Mini cocotte avec couvercle



REF	Ø cm	L cm	H cm	Lts	€/u	📦
P23505	10	13	7,5	0,20	20,30	12

P23507 High round casserole with lid
Cacerola alta con tapa
Cocotte haute avec couvercle



REF	Ø cm	H cm	Lts	€/u	📦
P23507	14	9,5	0,70	31,00	8

P23506 Mini oval pan with lid
Mini fuente oval con tapa
Mini plateau ovale avec couvercle



REF	W x D x H cm	L cm	€/u	📦
P23506	12 x 8 x 5	15,5	11,70	12

P23509 High mini oval pan with lid
Mini fuente oval alta con tapa
Mini plateau ovale haut avec couvercle



REF	W x D x H cm	Lts	€/u	📦
P23509	12,5 x 9,3 x 7,5	0,25	30,95	12

15.2 Wood serving boards

Tablas de madera
Planches en bois



P41008 Wood serving boards
Tablas de madera
Planches en bois

NEW!



REF	cm	€/u	
P41008	28 x 30,5	17,45	1

P41009 Wood serving boards
Tablas de madera
Planches en bois

NEW!



REF	cm	€/u	
P41009	40,5 x 30,5	21,40	1

P41010 Wood serving boards
Tablas de madera
Planches en bois

NEW!



REF	cm	€/u	
P41010	51,8 x 20,3	20,15	1

P41011 Wood serving boards
Tablas de madera
Planches en bois

NEW!



REF	cm	€/u	
P41011	36 x 17,5	22,65	1

Taco and sandwich tray 15.2

Tacos y bocadillos presentación
Présentation de Tacos et sandwiches



P41001 Taco tray. 2-3 compartments
Soporte tacos. 2-3 compartimentos
Plateau à Tacos 2-3 compartiments



REF	W x D x H cm	€/u	
P41001	21 x 10,2 x 5	6,70	1

P41002 Taco tray. 4-5 compartments
Soporte tacos. 4-5 compartimentos
Plateau à Tacos 4-5 compartiments



REF	W x D x H cm	€/u	
P41002	36 x 10,2 x 5	9,85	1

P41004 Taco tray with wooden base
Soporte tacos con base de madera
Plateau à tacos avec base en bois



REF	W x D x H cm	€/u	
P41004	44 x 10,8 x 6,5	27,80	1

P. 479

Ramekin / Sauce container
Recipiente para salsas
Récipient pour sauces



P41003 Sandwich tray. 7 compartments
Soporte bocadillos. 7 compartimentos
Plateau à sandwiches. 7 compartiments



REF	W x D x H cm	€/u	
P41003	44 x 10,8 x 6,5	21,50	1

15.2 Tin plates display

Llaunas presentación
Plateaux inox présentation



P296415 Stainless steel tray with handles

Llauna inox con asas
Plaque inox avec anses



REF	Base cm	Total W x D x H cm	€/u	
P296415	22 x 14	25,5 x 14 x 1,5	19,00	1
P296430	22 x 14	25,5 x 14 x 3	20,30	1
P296515	26,5 x 23	30 x 23 x 1,5	22,05	1
P296530	26,5 x 23	30 x 23 x 3	23,50	1
P296615	32 x 24	35,5 x 24 x 1,5	23,60	1
P296630	32 x 24	35,5 x 24 x 3	25,20	1
P296715	32 x 18	35,5 x 18 x 1,5	21,55	1
P296730	32 x 18	35,5 x 18 x 3	23,00	1

P296300 Cork base

Base de corcho
Base en liège



dishwasher

REF	W x D x H cm	Suitable for Compatible con Adaptable pour	€/u	
P296300	30 x 19 x 3	P296415 - P296430	20,50	1
P296400	34,5 x 28 x 3	P296515 - P296530	30,65	1
P296500	40 x 29 x 3	P296615 - P296630	34,75	1
P296600	40 x 23 x 3	P296715 - P296730	30,00	1

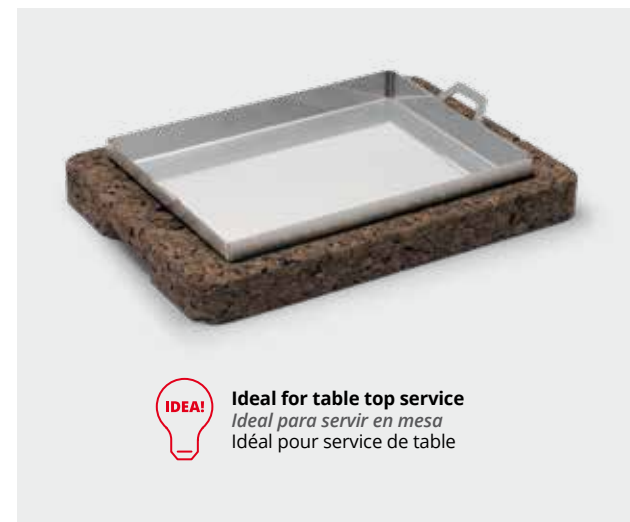

IDEA! Ideal for table top service
Ideal para servir en mesa
Idéal pour service de table

Tin plates display 15.2

Llaunas presentación
Plateaux inox présentation

P29680 Stainless steel presentation spatula

Pala presentación en inox
Pelle de présentation en inox



REF	Base cm	Total W x D x H cm	€/u	
P29680	23 x 16	38,6 x 16 x 11,5	20,70	1

P2965001 Triangular tray

Llauna triangular
Plaque triangulaire



REF	W x D x H cm	€/u	
P2965001	29 x 29 x 1,5	26,95	1

P29610 Sheet pan with wooden tray with handle

Llauna bandeja presentación rectangular con mango
Plateau de présentation avec manche



REF	Llauna W x D x H cm	Total W x D x H cm	€/u	
P29610	22 x 14 x 2	34 x 18 x 3	39,35	6

P29600 Sheet pan with wooden tray

Llauna bandeja presentación rectangular
Plateau de présentation



REF	Llauna W x D x H cm	Total W x D x H cm	€/u	
P29600	29,5 x 19,5 x 2	33 x 23 x 3	40,05	6

P1950 1/1 GN sheet pan

Llauna bandeja gastronorm 1/1 presentación
Plateau GN 1/1 de présentation



GN 1/1



REF	Llauna W x D x H cm	Total L cm	€/u	
P195000	48 x 32 x 2	52,5	46,80	6

P296 Round sheet pan with wooden tray

Llauna bandeja presentación redonda
Plateau rond de présentation



REF	Llauna Ø cm	H cm	Total L cm	H cm	€/u	
P29620	20	4,5	31	5,5	39,65	6
P29630	26	4,5	37	5,5	48,55	6



IDEA! Ideal for table top service
Ideal para servir en mesa
Idéal pour service de table

15.2 Slates

Pizarras
Ardoises



SI
Slate

Wo
Wood



dishwasher

Natural, elegant and exclusive presentation of cold or hot plates.

Presentación natural, elegante y exclusiva de platos fríos o calientes.

Présentation naturelle, élégante et exclusive de plats froids ou chauds.

P28600 Slate and acacia board

Tabla pizarra y acacia
Plateau ardoise et bois



REF	W x D x H cm	€ / u	
P28600	33 x 23 x 1,5	22,25	1

P28610 Slate and acacia board

Tabla pizarra y acacia
Plateau ardoise et bois



REF	W x D x H cm	L cm	€ / u	
P28610	26 x 18 x 1,5	34	18,50	1

P28620 Slate and acacia board

Tabla pizarra y acacia
Plateau ardoise et bois



REF	Ø cm	L cm	H cm	€ / u	
P28620	21,0	31	1,5	18,05	1
P28621	26,5	37	1,5	22,55	1

See products on

Ver productos en / Voir produits en page

P. 92

Display tray

Bandeja presentación
Plateau présentation



Slates 15.2

Pizarras
Ardoises

SI
Slate

P28202 Slate serving tray

Pizarra presentación
Ardoise presentation

BEST
SELLER



Polished edges
Cantos pulidos
Coins biseautés

Rubber feet
Pies espumados
Pieds mousse

4-5 mm
Thickness
Espesor
Epaisseur



REF	cm	€ / u	
P28202	20 x 20	3,85	24
P28252	25 x 25	6,15	16
P28303	30 x 30	8,15	12
P28302	30 x 20	5,95	16
P28403	40 x 30	10,70	10

P28501 Slate serving tray

Pizarra presentación
Ardoise presentation



REF	cm	€ / u	
P28501	25 x 25	6,15	1
P28502	30 x 30	8,15	1
P28503	30 x 20	5,80	1
P28504	40 x 30	10,50	1

P28505 Slate serving tray

Pizarra presentación
Ardoise presentation



REF	Ø cm	€ / u	
P28505	20	5,10	1
P28506	30	7,75	1

Natural edges
Cantos naturales
Coins naturels

5-6 mm
Thickness
Espesor
Epaisseur

Rubber feet
Pies espumados
Pieds mousse

Rough surface
Superficie rústica
Surface rustique

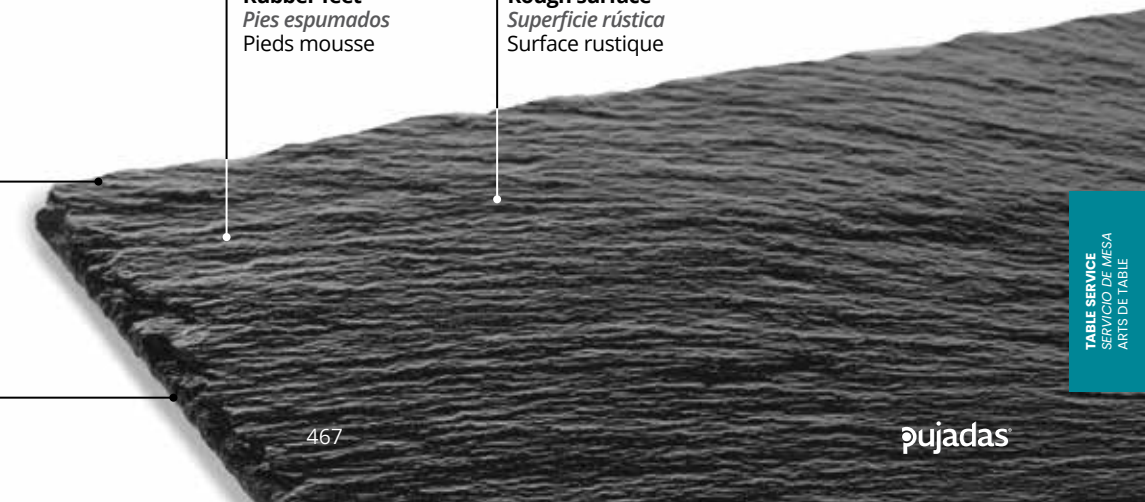

15.2 Natural bamboo

Bambú natural
Bambou naturel



NATURAL FIBERS

Natural bamboo presentation range for the most demanding hotels and restaurants.

Gama presentación bambú natural para los más exigentes.

Gamme de présentation bambou naturel plus exigeants.



P10051 Bamboo sushi board
Tabla bambú presentación sushi
Planche bambou présentation sushi



REF	W x D x H cm	€/ u	
P100511	24 x 15 x 3	14,15	24
P100512	27 x 18 x 3	17,65	24

P10052 Curved bamboo sushi board
Tabla curvada bambú sushi
Planche incurvée bambou présentation sushi



REF	W x D x H cm	€/ u	
P100520	21 x 12 x 2,5	12,10	36
P100521	24 x 15 x 3	14,80	24
P100522	27 x 18 x 3	18,30	24

P10060 Sushi boat presentation
Barco presentación sushi
Bateau présentation sushi



REF	W x D x H cm	€/ u	
P100600	50 x 20 x 31	115,25	6
P100601	70 x 25,5 x 45	153,85	8

Natural bamboo 15.2

Bambú natural
Bambou naturel



P10054 Round bamboo steamer
Vaporeira bambú redonda
Cuit vapeur bambou rond



Without lid
Sin tapa
Sans couvercle

REF	Ø cm	H cm	€/ u	
P100540	10	4,0	4,50	50
P100541	13	5,0	6,70	224
P100542	15	5,0	6,85	144
P100543	21	5,0	8,45	72
P100544	27	5,5	12,10	44

P10055 Round steamer lid
Tapa vaporeira redonda
Couvercle cuit vapeur rond



REF	Ø cm	H cm	€/ u	
P100550	10	3,0	4,30	500
P100551	13	3,5	6,00	272
P100552	15	3,5	6,45	204
P100553	21	4,0	7,70	102
P100554	27	4,0	11,35	60

P10053 Sushi rectangular tray
Bandeja rectangular presentación sushi
Plateau rectangulaire présentation sushi



REF	W x D x H cm	€/ u	
P100530	33 x 22,5 x 8	43,70	6
P100531	42 x 32 x 8,5	48,30	6

P10057 Bamboo tong
Pinza bambú
Pince bambou



REF	L cm	€/ u	
P100570	20,0	1,60	780
P100571	25,5	1,85	504
P100572	30,0	2,10	444

15.2 Baskets and breadbaskets

Paneras y cestas
Paniers et corbeilles



Mt
Metal

P876001 Metal cone basket
Cesta cono metal
Panier métal cône

Mt
Metal

NEW!



REF	cm	H cm	€/ u	
P876001	13 x 13	18	5,95	1

P876002 Metal cone basket 1 ramekin
Cesta cono metal 1 ramekin
Panier métal cône 1 ramequin

Mt
Metal

NEW!

Ramekin not included
Ramekin no incluido
Ramequin non inclus



Ramekin compatible
Compatible con ramekin
Compatible ramequin
P41007, P41013, P41014,
P41016, P41017, P41019 y
P41020

REF	cm	H cm	€/ u	
P876002	19 x 13	18	6,95	1

P876003 Metal cone basket 2 ramekins
Cesta cono metal 2 ramekines
Panier métal cône 2 ramequins

Mt
Metal

NEW!

Ramekin not included
Ramekin no incluido
Ramequin non inclus

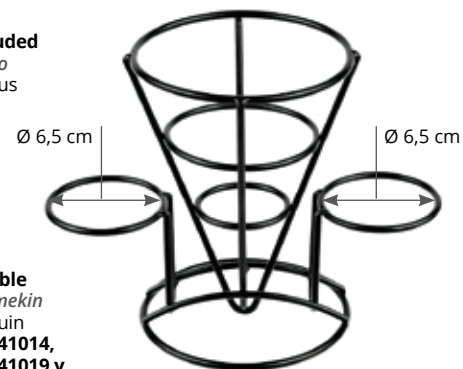

Ramekin compatible
Compatible con ramekin
Compatible ramequin
P41007, P41013, P41014,
P41016, P41017, P41019 y
P41020

REF	cm	H cm	€/ u	
P876003	25 x 13	18	7,95	1

See products on
Ver productos en / Voir produits en page

P. 479

Ramekins
Ramekins
Ramequins



Baskets and breadbaskets 15.2

Paneras y cestas
Paniers et corbeilles

Mt
Metal

P591001 Round metal basket
Cesta metal redonda
Panier métal rond

Mt
Metal

NEW!



REF	Ø cm	H cm	€/ u	
P591001	26,5	5	13,90	1

P591002 Oval metal basket
Cesta metal ovalada
Panier métal ovale

Mt
Metal

NEW!



REF	W x D x H cm	€/ u	
P591002	22,5 x 15 x 4,5	12,25	1

P591003 Rectangular metal basket
Cesta metal rectangular
Panier métal rectangulaire

Mt
Metal

NEW!



REF	W x D x H cm	€/ u	
P591003	23 x 10 x 4,5	11,85	1

P591004 Rectangular metal basket
Cesta metal rectangular
Panier métal rectangulaire

Mt
Metal

NEW!



REF	W x D x H cm	€/ u	
P591004	23 x 17,5 x 4,5	13,90	1

P591005 Round metal basket
Cesta metal redonda
Panier métal rond

Mt
Metal

NEW!



REF	Ø cm	H cm	€/ u	
P591005	20,5	13	14,95	1

Baskets and breadbaskets 15.2

Paneras y cestas
Paniers et corbeilles



P100816 Brown bread basket
Cesta pan marrón
Corbeille à pain marron

Washable
Se puede lavar
Peuvent se laver



P100807

REF	W x D x H cm	€/u	📦
P100816	13,0 x 13,0 x 15	7,35	12
P100807	17,5 x 17,5 x 15	10,10	12
P100836	26,5 x 26,5 x 12	12,85	12

P100808 Grey bread basket
Cesta pan gris
Corbeille à pain gris

Washable
Se puede lavar
Peuvent se laver



P100808

P100838

REF	W x D x H cm	€/u	📦
P100808	13,0 x 13,0 x 15	7,35	12
P100827	17,5 x 17,5 x 15	10,10	12
P100838	26,5 x 26,5 x 12	12,85	12

P100817 Black bread basket
Cesta pan negra
Corbeille à pain noir

Washable
Se puede lavar
Peuvent se laver



P100826

REF	W x D x H cm	€/u	📦
P100817	13,0 x 13,0 x 15	7,35	12
P100826	17,5 x 17,5 x 15	10,10	12
P100837	26,5 x 26,5 x 12	12,85	12



15.2 Baskets and breadbaskets

Paneras y cestas
Paniers et corbeilles



P100740 Bread basket
Cesta pan
Corbeille à pain



P100740

REF	W x D x H cm	€/u	
P100740	29 x 29 x 47,5	65,10	12

P100741 Bread basket
Cesta pan
Corbeille à pain



P100741

REF	W x D x H cm	€/u	
P100741	36 x 30 x 21 / 39	48,60	6
P100742	Ø 29 x 21 / 39	48,60	6



P100742

P100780 Bread basket
Cesta pan
Corbeille à pain



P100780

REF	Ø cm	H cm	€/u	
P100780	35	35	37,25	12

P10075 Slated bread basket
Cesta redonda inclinada
Corbeille ronde inclinée



REF	Ø cm	H cm	€/u	
P100754	36	10 / 20	24,10	6
P100755	40	13 / 23	30,95	6

P10076 Slated rectangular basket
Cesta rectangular inclinada
Corbeille rectangulaire inclinée



REF	W x D x H cm	€/u	
P100760	40 x 28 x 6 / 10	30,45	12
P100761	58 x 38 x 8 / 12	49,25	6

P10077 Two compartment rectangular basket
Cesta rectangular dos compartimentos
Corbeille rectangulaire deux compartiments



REF	W x D x H cm	€/u	
P100770	49 x 31 x 10 / 14,3	42,50	6

Baskets and breadbaskets 15.2

Paneras y cestas
Paniers et corbeilles



P10079 Round basket
Cesta redonda
Corbeille ronde



REF	Ø cm	H cm	€/u	
P100792	24	5,5	9,45	60

P10080 Round basket
Cesta redonda
Corbeille ronde



P100804

P100803

P100805

REF	Ø cm	H cm	€/u	
P100803	18	6,0	7,75	48
P100804	23	6,0	10,40	48
P100805	25	6,0	11,55	48

P10081 Round basket
Cesta redonda
Corbeille ronde

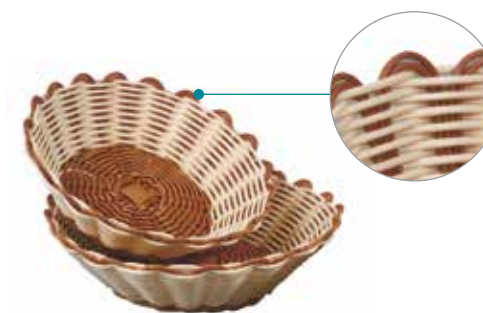

REF	Ø cm	H cm	€/u	
P100813	18,5	6,0	5,20	84
P100814	23,0	6,0	6,65	84

P10082 Round basket
Cesta redonda
Corbeille ronde

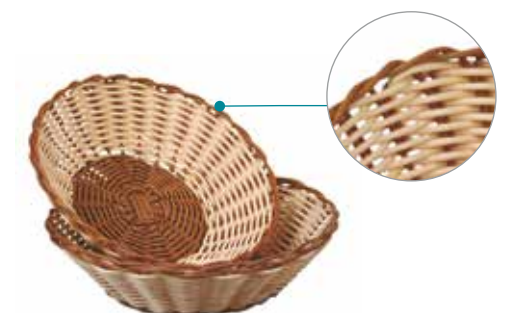

REF	Ø cm	H cm	€/u	
P100820	18,5	6,0	5,20	84
P100821	23,0	6,0	6,65	84

P10090 Oval basket
Cesta oval
Corbeille ovale



REF	W x D x H cm	€/u	
P100900	30 x 23,5 x 7,5	10,40	36

15.2 Baskets and breadbaskets

Paneras y cestas
Paniers et corbeilles

PP
Polypropylene

P10084 Rectangular basket
Cesta rectangular
Corbeille rectangulaire



REF	W x D x H cm	€/u	
P100840	21,5 x 18 x 8	9,45	84
P100841	26 x 20 x 7,5	8,45	48

P10085 Rectangular basket
Cesta rectangular
Corbeille rectangulaire



REF	W x D x H cm	€/u	
P100851	40 x 28,5 x 7	22,45	24

P10086 Rectangular basket
Cesta rectangular
Corbeille rectangulaire



REF	W x D x H cm	€/u	
P100860	37 x 27 x 7	19,85	24
P100861	46 x 34 x 7	26,90	24
P100862	46 x 34 x 12	32,30	12

P10087 Rectangular basket
Cesta rectangular
Corbeille rectangulaire



REF	W x D x H cm	€/u	
P100871	42 x 30 x 7	26,90	24

P10088 Oval basket
Cesta oval
Corbeille ovale



REF	W x D x H cm	€/u	
P100880	18 x 12 x 6,5	5,85	60
P100881	23,5 x 15 x 7	7,30	60
P100882	28 x 14,5 x 7,5	9,10	36

P10089 Oval basket
Cesta oval
Corbeille ovale



REF	W x D x H cm	€/u	
P100890	19 x 13 x 7	6,90	48
P100891	25 x 15 x 8	9,45	60
P100892	29 x 19 x 10	10,65	60

Baskets and breadbaskets 15.2

Paneras y cestas
Paniers et corbeilles

PP
Polypropylene

P10093 Cutlery dispenser
Cesta para cubiertos
Corbeille à couverts



REF	W x D x H cm	€/u	
P100931	30 x 11 x 7	9,50	96
P100932	30 x 11 x 7	9,50	96

P10094 Cutlery dispenser
Cesta para cubiertos
Corbeille à couverts



REF	Ø cm	H cm	€/u	
P100940	13	14	7,75	36

P10095 Rectangular buffet basket
Cesta buffet rectangular
Corbeille rectangulaire buffet

PE
Polyethylene

PC
Polycarbonate

GN 1/1



* Lid
Tapa
Couvercle

REF	cm	Total H cm	Base H cm	€/u	
P100950	53 x 31,5	26,0	8,5	38,00	12
P100951	53 x 31,5	26,0	8,5	38,00	12
P100955*				70,60	6

P10096 Round buffet basket
Cesta buffet redonda
Corbeille ronde buffet

PE
Polyethylene

PC
Polycarbonate



* Lid
Tapa
Couvercle

REF	Ø cm	H cm	€/u	
P100960	40	30	24,70	24
P100965*			37,35	6

15.2 Place mats

Manteles individuales
Sets de table

PVC

Place mats made of PVC + polyester.
To clean please use a damp sponge or cloth.

Manteles individuales fabricados en PVC + poliéster. Para su limpieza se aconseja usar una esponja o trapo húmedo.

Sets de table fabriqués en PVC + polyester.
Nettoyer à l'aide d'une éponge ou un chiffon humide.

P92605 DECO place mats

Manteles individuales DECO
Sets de table DECO

PVC

REF	cm	€/ PACK 6u	
P926051	45 x 30	17,90	20
P926052	45 x 30	17,90	20
P926053	45 x 30	17,90	20

Price / Precio / Prix : Pack 6 u.

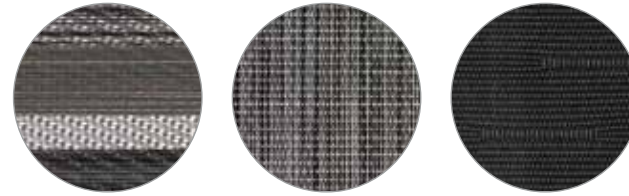

Brown&Black Lines
Líneas marrones-negras
Lignes marrons et noirs
P926051

Brown&Black
Marrón-negro
Marron et noir
P926052

Black
Negro
Noir
P926053

P9260 Place mat fine band

Mantel individual trama fina
Set de table maille fine

REF	cm	€/ u	
P926006	45 x 30	17,90	20
P926007	45 x 30	17,90	20
P926008	45 x 30	17,90	20
P926009	45 x 30	17,90	20

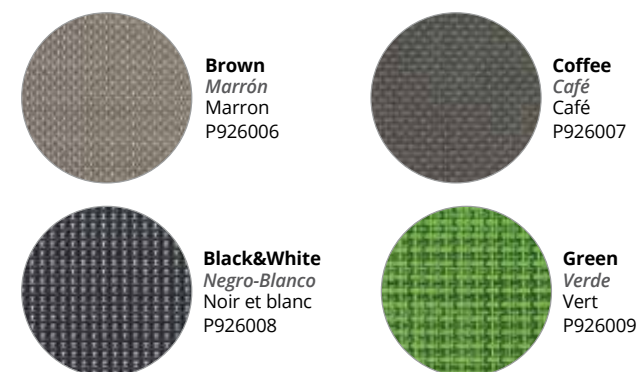

Brown
Marrón
Marron
P926006

Coffee
Café
Café
P926007

Black&White
Negro-Blanco
Noir et blanc
P926008

Green
Verde
Vert
P926009

P926 Place mat wide band

Mantel individual trama gruesa
Set de table maille épaisse

REF	cm	€/ u	
P926002	45 x 30	18,30	20
P926003	45 x 30	18,30	20
P926004	45 x 30	18,30	20
P926005	45 x 30	18,30	20
P926010	45 x 30	17,90	20
P926011	45 x 30	17,90	20
P926012	45 x 30	17,90	20

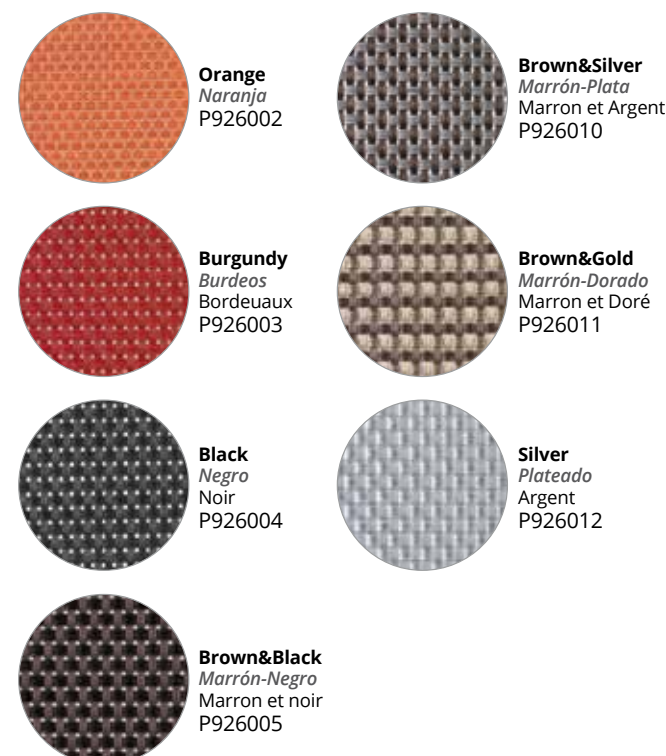

Orange
Naranja
P926002

Brown&Silver
Marrón-Plata
Marron et Argent
P926010

Burgundy
Burdeos
Bordeaux
P926003

Brown&Gold
Marrón-Dorado
Marron et Doré
P926011

Black
Negro
Noir
P926004

Silver
Plateado
Argent
P926012

Brown&Black
Marrón-Negro
Marron et noir
P926005

Flared sauce cups 15.3

Salseras
Saucières

P4100 Ramekin / Sauce container

Recipiente para salsas
Récipient pour sauces

SS
Stainless steel

NEW!



Price / Precio / Prix : Pack 12 u.

REF	Ø cm	H cm	ml	€/ PACK 12u	
P41005	6,2	2,75	45	5,90	12
P41006	5,8	4,50	75	6,65	12
P41007	7,4	5,20	135	13,10	12

P4101 Ramekin / Sauce container

Recipiente para salsas
Récipient pour sauces

PET

NEW!



Price / Precio / Prix : Pack 12 u.

REF		Ø cm	H cm	ml	€/ PACK 12u	
P41012	white	6,0	3,5	45	8,85	12
P41013	blanco	7,0	3,5	60	10,90	12
P41014	blanc	7,5	4,0	90	12,95	12
P41015	black	6,0	3,5	45	8,85	12
P41016	negro	7,0	3,5	60	10,90	12
P41017	noir	7,5	4,0	90	12,95	12
P41018	transparent	6,0	3,5	45	8,85	12
P41019	transparente	7,0	3,5	60	10,90	12
P41020	transparent	7,5	4,0	90	12,95	12

P623 Snack bowl set or sauce bowl set

Portasalados o portasalzas
Ensemble bols pour snacks ou sauces

SS
Stainless steel



REF	UNI.	Ø cm/u	ml/u	€/ u	
P623003	3	9	200	49,45	25

P333 Gravy boat

Salsera
Saucière

SS
Stainless steel



REF	L	€/ u	
P333010	0,10	6,45	72
P333020	0,20	10,35	36
P333035	0,35	11,80	24

15.3 Table accessories

Complementos de mesa
Accessoires de table



P638003 Table caddy. 3 Compartments
Caddy de mesa. 3 Compartimentos
Caddy de table. 3 compartiments

Galvanised steel
Acero galvanizado
Acier galvanisé

Wooden handle
Asa de madera
Manche en bois



dishwasher



REF	W x D x H cm	€/u	📦
P638003	26 x 10 x 12	16,90	6

P638004 Table caddy. 4 Compartments
Caddy de mesa. 4 Compartimentos
Caddy de table. 4 compartiments

Galvanised steel
Acero galvanizado
Acier galvanisé

Wooden handle
Asa de madera
Manche en bois



dishwasher



REF	W x D x H cm	€/u	📦
P638004	26 x 18 x 12	22,30	6

Table accessories 15.3

Complementos de mesa
Accessoires de table

P96700 Pepper mill-salt mill. Wooden
Molinillos pimienta y sal. Madera
Moulin à poivre et sel. Bois



REF	H cm	€/u	📦
P967007	12,5	13,05	1
P967008	15,0	15,00	1
P967009	19,5	17,60	1

P967 Pepper mill-salt mill. Acrylic
Molinillos pimienta y sal. Acrílico
Moulin à poivre et sel. Acrylique



REF	Type / Tipo	H cm	€/u	📦
P967001	A	15,5	14,90	48
P967002	A	20,0	16,10	48
P967003	A	23,0	17,15	48
P967004	B	15,5	11,15	48
P967005	B	20,0	12,45	48
P967006	B	23,0	13,60	48

P630 Number card holder
Soporte para número "banquete"
Support numéro "banquet"



REF	H cm	€/u	📦
P630010	10	11,15	50
P630020	20	12,45	50
P630030	30	14,10	50
P630040	40	17,30	50

P632 Table number
Número de mesa
Numéro de table

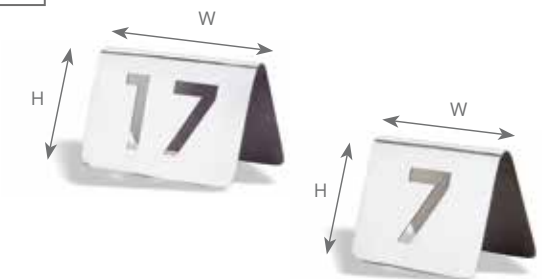

N. 1 - N. 30 ** number with 2 digits.
** número de 2 dígitos.
** numero de 2 chiffres.
* number with 1 digit.
* número de 1 dígito.
* numero d'un seul chiffre.

REF	W x H cm	€/u	📦
P63200 + NUM*	6,4 x 5,6	3,00	1
P6320 + NUM**	7,6 x 5,6	3,00	1

P633 "Reserved" table sign
Placa "Reservado"
Plaque "reserve"



REF	Text	W x H cm	€/u	📦
P633000	RESERVADO	10 x 5	4,60	300
P633002	RESERVED	10 x 5	4,60	200
P633003	RESERVE	10 x 5	4,60	310

P634 "Non-smoking" sign
Placa "Prohibido fumar"
Plaque "Défense de fumer"



REF	W x H cm	€/u	📦
P634000	7,6 x 5,6	3,95	100

15.3 Table accessories

Complementos de mesa
Accessoires de table

P969 Stand for tray
Soporte elevador
Support pour plateau



REF	Ø cm	H cm	€/u	
P969000	25 / 20	19,0	29,60	12

P968 Carry-skewers
Porta pinchos
Porte-brochettes



REF	Ø cm	H cm	€/u	
P968000	22	46	37,05	1

P8621 Non slip oval serving tray
Bandeja oval antideslizante
Plateau antidérapant forme ovale



Black color
Color negro
Couleur noir

REF	cm	€/u	
P862100	68 x 56	42,35	6

P9681 Skewer
Pincho
Brochette



Price 12 units box.
Precio caja 12 unidades.
Prix colis 12 unités.

REF	L cm	€/u	
P968125	25	7,10	1
P968130	30	8,05	1
P968135	35	9,05	1

P874 Bill spike
Pinchanotas
Epingle porte-tickets



REF	Ø cm	H cm	€/u	
P874000	9	22	5,15	50

P863 Large tray holder
Soporte para bandejas de gran tamaño
Support pour grands plateaux



Serving tray not included.
No incluye bandeja.
Plateau non inclus.

REF	W x D x H cm	€/u	
P863000	47 x 47 x 76,5	124,35	6

Table accessories 15.3

Complementos de mesa
Accessoires de table



P650 St/Steel table-tidy
Papelera sobremesa acero inox
Receptacle à déchets de table



REF	Ø cm	H cm	€/u	
P650000	12	21	17,50	36

P638 Water ashtray
Cenicero de agua
Cendrier à eau



REF	Ø cm	H cm	€/u	
P638000	11	5,5	9,15	100

P625 Table crumber
Pala recogemigas
Pelle ramasse-miettes



REF	A x B x C cm	€/u	
P625000	18 x 7 x 12,5	8,75	144

P357 Napkin holder
Servilletero
Porte-serviettes



REF	H x W x D cm	€/u	
P357000	13 x 9,8 x 10	12,80	72

P639 Deep ashtray
Cenicero hondo
Cendrier profond



REF	H x W x D cm	€/u	
P639000	2,5 x 12,5 x 12,5	4,25	200

See products on
Ver productos en / Voir produits en page

P. 383

Melamine
Melamina
Mélamine



15.3 Menu holders

Portamenús
Porte-menus

- Made of PVC.
- Pockets on each back cover.
- For DIN A4 and DIN A5 sheets.

- Fabricado en PVC.
- Bolsillos en contratapa interior.
- Para hojas DIN A4 y DIN A5.

- Fabriqué en PVC.
- Poches avec couverture intérieure.
- Pour feuilles DIN A4 et DIN A5.

P2004 Elegance menu holder

Portamenús Elegance
Porte-Menus Elegance

PVC



Up to 10 pages: cover back + 4 double inner pages + back cover front.

Para 10 páginas: 4 fundas dobles + 2 laterales.

Pour 10 pages: 4 feuilles plastiques doubles + 2 latérales.

REF	cm	Colour / Color	€/u	📦
P20041	33 x 24	Burdeos / Burgundy / Bordeaux	14,40	1
P20042	33 x 24	Negro / Black / Noir	14,40	1

P636 Menu holder

Portamenús
Porte-menu de table

SS
Stainless steel



REF	H cm	€/u	📦
P636000	2	5,40	200

P20066 Bill Holder

Porta facturas
Porte-addition



REF	W x H cm	Colour / Color	€/u	📦
P20066	24,5 x 17	Negro / Black / Noir	25,80	1
P20069	20 x 13,5	Negro / Black / Noir	23,70	1

P20050 Elegance Bill holder

Porta blocs Elegance
Porte-addition Elegance

PVC



REF	cm	Colour / Color	€/u	📦
P20050	23 x 13	Negro / Black / Noir	8,85	72

P637 Bill holder

Platillo cambio
Porte-addition

SS
Stainless steel



REF	cm	€/u	📦
P637000	15,5 x 11	4,55	200
P637100	21,5 x 12,5	5,40	120

P635 Card holder

Portatarjetas
Porte-cartes

SS
Stainless steel

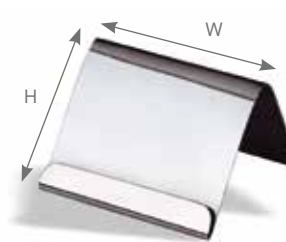

REF	W x H cm	€/u	📦
P635000	6,2 x 5,2	3,95	500

Food & table service 15.4

Servicio de mesa
Arts de table

Plate Covers

Tapas para platos
Couvercles à assiette

Plate covers keep food at its ideal serving temperature for improved customer satisfaction. Hemmed finger hole.

Las tapas para platos mantienen la comida a la temperatura ideal para servir. Se ofrecen con orificio central.

Les couvre-assiettes maintiennent les aliments à la température idéale de service pour améliorer la satisfaction du client. Trou ourlé pour passer le doigt.



62300 Stainless Steel Plate Covers

Tapas Acero inoxidable para platos
Inox couvercles à assiette

SS
Stainless steel

Stackable
Apilable
Empilable



Satin-finish keeps covers looking better longer
El acabado satinado mantiene más tiempo el buen aspecto de las tapas
Fini satin pour un attrait durable

REF	For / Para / Pour Ø cm	H cm	€/u	📦
62300	22,9 - 23,2	5,9	25,00	12
62301	23,3 - 23,5	5,9	25,00	12 NEW
62303	24,0 - 24,1	5,9	25,00	12
62305	24,6 - 24,8	5,9	25,00	12 NEW
62309	25,9 - 26,0	5,9	27,20	12 NEW
62311	26,5 - 26,7	5,9	27,20	12 NEW
62312	26,8 - 27,0	5,9	27,20	12
62313	27,1 - 27,3	5,9	27,20	12
62314	27,5 - 27,6	5,9	27,20	12 NEW
62315	27,8 - 27,9	5,9	27,20	12
62318	28,1 - 28,3	5,9	30,95	12
62321	29,1 - 29,2	5,9	30,95	12
62322	29,4 - 29,5	7,1	31,55	12 NEW
62323	29,7 - 29,8	7,1	31,55	12 NEW
62325	30,3 - 30,5	7,1	36,80	12 NEW
62326	30,6 - 30,8	5,9	35,60	12
62327	31,0 - 31,1	7,1	36,80	12 NEW
62328	31,3 - 31,4	7,1	36,80	12 NEW

918 Plastic Plate Covers

Tapas plástico para platos
Plastique couvercles à assiette

PC
Polycarbonate

+ 93°C

Stackable
Apilable
Empilable

Clear
Transparente
Transparent

Dishwasher
Lavavajillas
Lave-vaisselle



REF	For / Para / Pour Ø cm	H cm	€/u	📦
918-13	21,6 - 23,2	6,7	13,05	12
1078-13	26,7 - 27,0	7,0	16,10	12
1100-13	28	7,2	17,50	12 NEW
1200-13	30,50	7,2	18,50	12 NEW

Ask about other available sizes
Consultar otras medidas disponibles
Consulter autres dimensions disponibles

16 Bar & coffee

Bar y cafetería
Bar et cafétéria



16.1 BEVERAGE TROLLEY 488

CARRO BEBIDAS / CHARIOT BOISSONS

Cocktail trolley / Carro cocktail / Chariot cocktail 488
Liquor trolley / Carro licor / Chariot à liqueurs 490

16.2 BAR 491

Wine Buckets / Cubiteras / Seaux à champagne 491
Cocktail Service / Coctelería / Cocktail 496
Bar Mats / Alfombras para bar / Tapis de bar 498
Condiment Dispensers / Dispensador de condimentos
Distributeur de condiments 499
Wine Complements / Complementos de vino / Accessoires de vin 500
Trays / Bandejas / Plateaux 501

16.3 TEA & COFFEE SERVICE 502

TÉ Y CAFETERÍA / THÉ ET CAFÉTÉRIA

Planet 502
Cosmos 504
Atlantis 504
Tea Pots / Teteras / Théières 505

16.4 BEVERAGE SERVICE 506

SERVICIO DE BEBIDAS / SERVICE À BOISSONS

Servers / Servidores / Verseuses 506
Pitchers / Jarras / Pichets 508

16.5 LIDSAVERS AND CUPDISPENSERS 510

DISPENSADORES DE TAPAS Y VASOS
DISTRIBUTEUR DE COUVERCLES ET GOBELETS

16.1 Cocktail trolley

Carro cocktail / Chariot cocktail

Trolley with an innovative and versatile design, with multiple storage spaces and a large work area.

Carro de diseño innovador y versátil, con múltiples espacios de almacenaje y una amplia zona de trabajo.

Chariot au design innovant et polyvalent, avec de multiples espaces de rangement et un grand espace de travail.

Carbon steel structure with anti-rust coating and satin black paint.

Estructura de acero al carbono con recubrimiento antioxidante y pintura negra satinada.

Structure en acier au carbone avec revêtement antioxydant et peinture noire satinée.

NEW!



It can be customized with a logo.
Se puede personalizar con logo.
Personnalisable avec logo.

Elements of the work area in stainless steel.

Elementos del área de trabajo en acero inoxidable.

Éléments de la zone de travail en acier inoxydable.

Solid anti-humidity board with oak finish.

Tablero macizo antihumedad acabado roble.

Panneau massif anti-humidité finition chêne.

Drawer with metal runners

Cajón con guías metálicas

Tiroir avec guides métalliques



Revolving casters, two with brakes

Ruedas giratorias, dos con frenos

Roues giratoires, deux avec freins

5 rails for hanging glasses

5 railes para colgar copas

5 rails pour suspendre les verres



REF	W x D x H cm	€/u	📦
P90910	132,5 x 63 x 98,5	3.495,00	1

Cocktail trolley 16.1

Carro cocktail
Chariot cocktail

Elements included:

Elementos incluidos:

Éléments inclus :

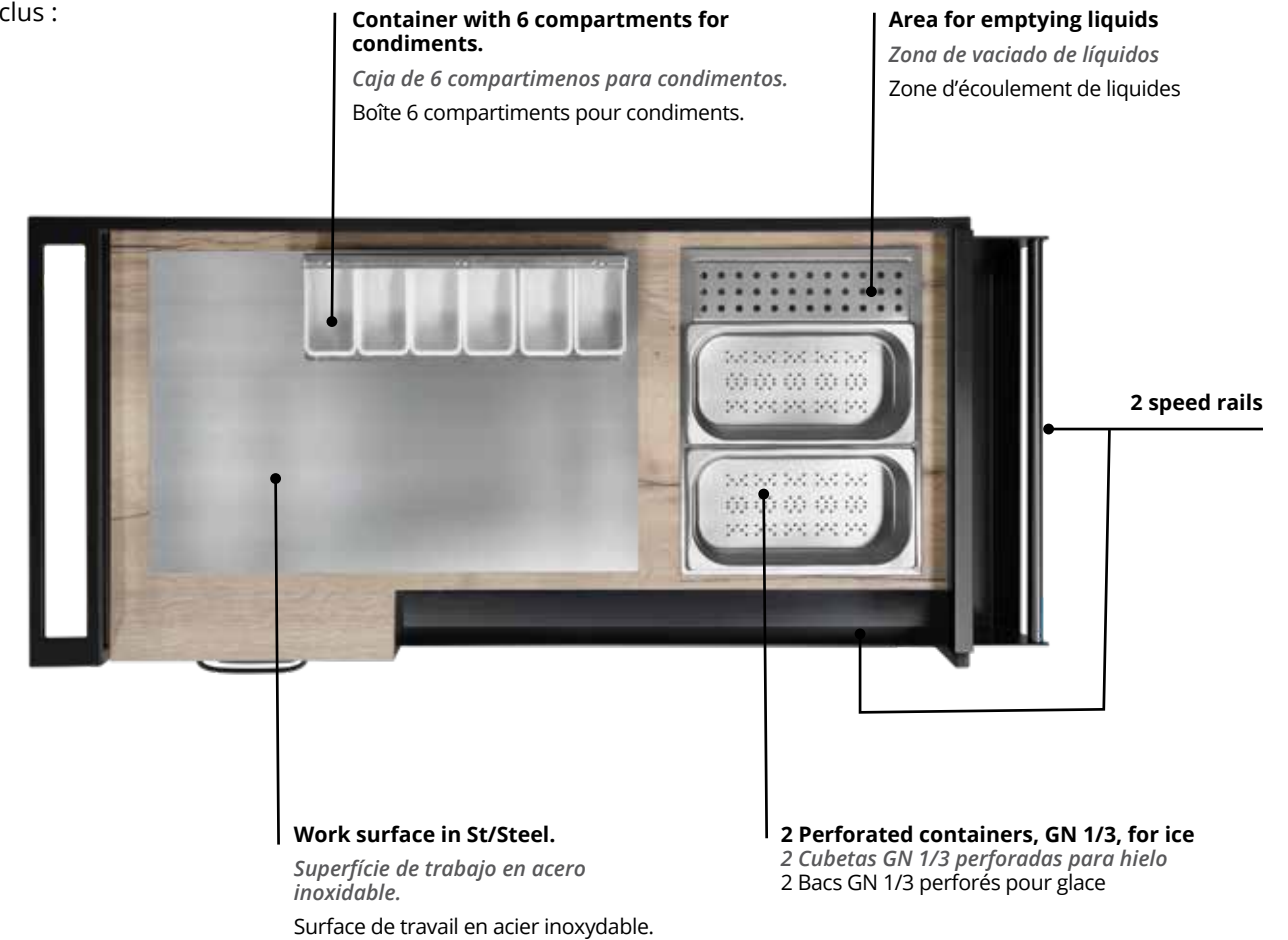

P90910 Cocktail trolley with stainless steel work module

Carro cocktail con área de trabajo

Chariot à cocktails avec zone de travail



REF	W x D x H cm	€/u	📦
P90910	132,5 x 63 x 98,5	3.495,00	1

P90911 Hanging bottle rack

Botellero colgante

Porte-bouteilles suspendu



Maximum 3 per trolley
Máximo 3 por carro.
Maximum 3 par chariot.

REF	W x D x H cm	€/u	📦
P90911	59,5 x 12 x 23,5	139,00	1

16.1 Liquor trolley

Carro licor
Chariot à liqueurs



NEW!

Carbon steel structure with anti-rust coating and satin black paint.

Estructura de acero al carbono con recubrimiento antioxidante y pintura negra satinada.

Structure en acier au carbone avec revêtement antioxydant et peinture noire satinée.

REF	W x D x H cm	€ / u	
P90930	91,5 x 63 x 98	2.195,00	1

3 speed rails

Solid anti-humidity board with oak finish.

Tablero macizo antihumedad acabado roble.

Panneau massif anti-humidité finition chêne.

3 rails for hanging glasses

3 railes para colgar copas
3 rails pour suspendre les verres

Area for rocks glasses.
20-glass capacity.

Zona para vasos de licor.
Capacidad para 20 vasos.
Zone pour verres à liqueur.
Capacité pour 20 verres.

Shelves for mixers

Estanterías para mixers
Étagères pour mixers



Wine Buckets 16.2

Cubiteras
Seaux à champagne



P972 Champagne bucket
Cubo champán
Seau à champagne

SS
Stainless
steel



dishwasher

NEW!



Sophistication and durability

Sofisticación y durabilidad
Sophistication et durabilité

Elevate the presentation of your drinks. Add a touch of sophistication with these ice buckets made from stainless steel, painted in stylish colours on the outside.

Eleva la presentación de tus bebidas. Añade un toque de sofisticación con estas cubiteras realizadas en acero inoxidable y pintadas en elegantes colores por la parte exterior.

Sublimez la présentation de vos boissons. Apportez une note de sophistication aux seaux à glace en acier inoxydable avec revêtements extérieurs élégants.

REF	Ø cm	H cm	Colour / Color	€ / u	
P972201	21	20	Gold / oro / or	19,25	1
P972202	21	20	Black / negro / noir	19,25	1
P972203	21	20	Copper / cobre / cuivre	19,25	1

P976 Hammered champagne bucket with handles
Cubo champán hammered con asas
Seau à champagne martelé avec poignées

SS
Stainless
steel

NEW!



47620 Champagne bucket with fixed handles
Cubo champán con asas fijas
Seau à champagne à poignées fixes

SS
Stainless
steel

NEW!



REF	Ø cm	H cm	€ / u	
P976210	21	20	19,60	1

REF	Ø cm	H cm	€ / u	
47620	21	19,7	77,50	1

16.2 Wine Buckets

Cubiteras
Seaux à champagne



P311F71 Conical champagne bucket with rings
Cubo champán cónico con anillas
Seau à champagne conique à anneaux



REF	Ø cm	H cm	€/u	
P311071	20	19,5	37,25	1

P311F2 Champagne bucket with fixed handles
Cubo champán con asas fijas
Seau à champagne à poignées fixes



REF	Ø cm	H cm	€/u	
P311002	18	19	33,00	1

P311F6 Champagne bucket with rings
Cubo champán con anillas
Seau à champagne à anneaux



REF	Ø cm	H cm	€/u	
P311006	18	19	33,00	1

P326 Champagne bucket two bottles
Cubo champán dos botellas
Seau à champagne deux bouteilles



REF	Ø cm	H cm	€/u	
P326000	25	22	42,30	1

P9762 Conical champagne bucket with handles
Cubo champán cónico con asas
Seau à champagne conique avec poignées



REF	Ø cm	H cm	€/u	
P976200	21	20	17,45	24

P9763 Conical champagne bucket with rings
Cubo champán cónico con anillas
Seau à champagne conique à anneaux



REF	Ø cm	H cm	€/u	
P976300	19	19	16,75	24

Wine Buckets 16.2

Cubiteras
Seaux à champagne



P312 Ice bucket with separative disk
Cubo para hielo con disco separador
Seau à glaçons avec disque de séparation



REF	Ø cm	H cm	€/u	
P312000	11	13	23,50	50

P310 Ice cube bowl
Cubitera tipo ensaladera
Vasque



REF	Ø cm	H cm	Lts	€/u	
P310000	40	24,5	13	98,05	1

P3110 St/Steel bucket-holder stand
Pie portacubos acero inox
Pied porte-seau



* Suitable for references
Compatible con los modelos
Compatible avec les références
P311.F2, P311.F6, P311.F71

** For 2 bottles bucket
Para cubitera 2 botellas
Pour seau à champagne
2 bouteilles

REF	Ø cm	H cm	€/u	
P311004*	18	67,5	70,40	1
P311020**	22	69,0	76,40	1

P974 Double wall insulated cooler
Enfriador isotérmico doble pared
Rafraîchisseur isotherme double paroi



REF	Ø cm	H cm	€/u	
P974000	10,5	20	21,30	24

P327 Ice cube bowl
Cubitera tipo ensaladera
Vasque



REF	Ø cm	H cm	Lts	€/u	
P327000	35	25	10	82,50	1

47611 St/Steel bucket-holder stand
Pie portacubos acero inox
Pied porte-seau



NEW!

REF	Ø cm	H cm	€/u	
47611	19,5	60	236,10	1

16.2 Wine Buckets

Cubiteras
Seaux à champagne



dishwasher



P988400 Plastic champagne bucket
Cubitera de plástico
Seau à champagne



REF	Ø cm	H cm	€/u	
P988400	21	21,5	9,75	6

P988500 Bi-color plastic champagne bucket
Cubitera bicolor plástico
Seau à champagne bicolore



REF	Ø cm	H cm	€/u	
P988500	19	21	16,20	1

P988600 Oval plastic champagne bucket
Cubitera ovalada plástico
Seau à champagne ovale



REF	W x D x H cm	€/u	
P988600	32,5 x 23,5 x 22	21,35	1

P988700 Plastic champagne bucket
Cubitera de plástico
Seau à champagne



REF	Ø cm	H cm	€/u	
P988700	19,5	21	11,00	1

VOLLRATH

494

pujadas

Wine Buckets 16.2

Cubiteras
Seaux à champagne

P988900 Oval plastic champagne bucket
Cubitera ovalada plástico
Seau à champagne ovale



REF	W x D x H cm	€/u	
P988900	44,5 x 41,5 x 25	37,20	1

P9881 Conical acrylic champagne bucket
Cubitera cónica acrílica
Seau à champagne conique



REF	Ø cm	H cm	€/u	
P988100	20	18,5	11,40	12

P9882 Oval acrylic champagne bucket
Cubitera ovalada acrílica
Seau à champagne ovale



*3 BOTTLES
*3 BOTELLAS
*3 BOUTEILLES

REF	W x D x H cm	€/u	
P988200	27 x 20 x 20	24,50	12
P988300*	35 x 26 x 27	41,80	6

P646 Champagne bucket holder
Soporte de mesa para cubo champán
Support de table pour seau à champagne



VOLLRATH

495

P990 Wine cooler
Manta enfriadora
Rafrichisseur

Reversible:
burgundy and silver
Reversible:
burdeos y plata
Réversible:
bordeaux et argenté



REF	cm	€/u	
P990000	35 x 18	8,50	55

Suitable with all champagne bucket but:
Compatible con todos los modelos de cubos champán excepto con:
Compatible avec tous les modèles sauf :
ref. P326

REF	Ø cm	cm	€/u	
P646000	18	52 x 17	36,60	4

pujadas

16.2 Cocktail Service

Cocteleria
Cocktail



P330 Shaker

Coctelera
Shaker



REF	H cm	Lts	€ / u	
P330035	18,0	0,35	16,45	72
P330050	20,5	0,50	19,95	72
P330070	23,5	0,70	26,95	48

46793 Bar shaker

Coctelera
Shaker



Mirror-finished stainless steel. Reinforced bases
Acero inoxidable brillante. Bases reforzadas
Acier inoxydable ultra-brillant. Bases renforcées

REF	Ø cm	H cm	ml	€ / u	
46793	9,2	17,8	900	21,40	12
46791	8,64	11,4	455	19,60	12

48070 Malt cup

Vaso para malteado
Verre à milkshake



NEW!

Reinforced base. Ideal for malts, milkshakes, ice cream and more.
Bases reforzadas. Ideal para malts, batidos, helados y más.
Bases renforcées. Idéal pour les malts, les milkshakes, la crème glacée et plus encore.

REF	Ø cm	H cm	ml	€ / u	
48070	10,2	17,1	900	23,60	12

See products on P. 457
Ver productos en / Voir produits en page



Cocktail Service 16.2

Cocteleria
Cocktail



P388 Ice tong

Pinza hielo
Pince à glace



REF	L cm	€ / u	
P388018	18,5	4,05	100

46790 Bar scoop

Cuchara de bar
Pelle à bar



NEW!

Sturdy handle provides a comfortable, reliable grip.
El mango resistente proporciona un agarre cómodo y fiable.
La poignée robuste offre une prise en main confortable et fiable.

REF	€ / u	
46790	8,30	24

46787 Cocktail strainer

Colador para cócteles
Passoire à cocktail

NEW!



Four prongs provide stability. Removable spring ensures easy and efficient cleaning.

Las cuatro puntas ofrecen estabilidad. El resorte extraíble garantiza una limpieza fácil y eficiente.
Quatre broches assurent la stabilité. Le ressort amovible assure un nettoyage facile et efficace.

REF	W x D cm	€ / u	
46787	11,5 x 15,7	7,90	12

P319 Cocktail spoon

Cuchara batidora
Cuillère à cocktail



REF	L cm	€ / u	
P319000	26,5	5,10	300
P319100	28,0	3,65	360

47104 Ice tong

Pinza hielo
Pince à glace



REF	L cm	€ / u	
47104	15,9	8,60	12

P3181 Cocktail strainer

Colador gusanillo
Passoire à cocktail

Four prongs provide stability. Removable spring ensures easy and efficient cleaning

Las cuatro puntas ofrecen estabilidad. El resorte extraíble garantiza una limpieza fácil y eficiente.

Quatre broches assurent la stabilité. Le ressort amovible assure un nettoyage facile et efficace.



REF	Ø cm	W x D cm	€ / u	
P318100	7,6	11,7 x 15	7,65	144

P616 Lemon squeezer

Exprime limones
Presse citron



REF	Ø cm	€ / u	
P616000	17	7,80	144

P399 Jigger

Dosificador licor
Mesure à cocktail



REF	Ø cm	H cm	ml	€ / u	
P399000	A 3,7 B 4,1	A 2,8 B 5,7	25 50	12,80	200

16.2 Bar mats

Alfombras para bar
Tapis de bar

P26100 Bar mat
Alfombra de bar para escurrido de copas
Tapis égouttoir pour verres



They can be connected with each other forming bigger surfaces
Se pueden conectar unas con otras formando mayores superficies
Avec système de liaison pour composer une surface plus grande

REF	W x D x H cm	€ / u	
P26100	30 x 30 x 1,20	9,40	1

2331 Service mat
Alfombra bar rectangular
Tapis de service



Flexible thermoplastic rubber
Caucho termoplástico flexible
Caoutchouc thermoplastique flexible

REF	W x D x H cm	€ / u	
2331-99	45,7 x 30,5 x 1,3	49,15	6

3616 Bar keep
Botella bar
Bouteille de bar



Includes:
1 neck + 1 jar + 1 lid + 6 assorted colored spouts.

El juego incluye:
1 cuello + 1 jarra + 1 tapa + 6 picos estándar de diversos colores.

Le kit comprend:
1 goulot + 1 récipient + 1 couvercle
+ assortiment de 6 becs verseurs standard en couleurs.

REF	Lts	cm	€ / u	
3616	0,47	25,7 x 9,20	9,10	12
3632	0,95	34,0 x 9,50	10,00	12
3648	1,40	38,1 x 16,5	11,30	6
3664	1,90	34,90 x 12,7	11,95	6
3628	3,80	43,2 x 14,0	18,10	6

Condiment dispensers 16.2

Dispensador de condimentos
Distributeur de condiments

4741-06 Condiment Bar Dispenser. Black
Caja condimentos negra
Boîte à condiments



4741-06



4743-06

REF	W x D x H cm	Lts	Compart.	€ / u	
4741-06	30,5 x 15,2 x 11,4	1,9	4	72,85	1
4743-06	45,7 x 15,2 x 15,6	2,8	6	87,35	1

- Not dishwasher safe.
- Transparent polycarbonate lid with automatic closure.
- The lid design increases the capacity and allows the item to be filled.
- Lids with holes allow utensils to be stored inside with the lid closed.
- Chiller plates are located on the bottom, keeping the condiments cool.

- No aptos para lavavajillas.
- Tapa policarbonato transparente con cierre automático.
- El diseño de la tapa aumenta la capacidad y permite llenar el artículo.
- Las tapas con orificios permiten mantener el utensilio dentro con la tapa cerrada.
- Las placas enfriadoras se colocan en la parte inferior, manteniendo los condimentos fríos.

- Pas adapté pour lave-vaisselle.
- Couvercle en polycarbonate transparent avec fermeture automatique.
- La conception du couvercle augmente la capacité et permet de remplir l'article.
- Les couvercles avec orifices permettent de garder l'ustensile à l'intérieur avec le couvercle fermé.
- Les plaques de refroidissement sont placées sur la partie inférieure, en conservant les condiments froids.

4747 Cooling plate for condiment holder
Placa enfriadora para caja condimentos
Plaque réfrigérante pour Boîte à condiments



REF	W x D x H cm	€ / u	
4747	13,2 x 11,4 x 2,9	7,70	6

P3994 Condiment holder
Caja condimentos
Condiments



REF	W x D x H cm	L / Compart.	€ / u	
P399400	30 x 14 x 8,5	0,45 x 4	29,05	12
P399500	38 x 14 x 8,5	0,45 x 5	32,80	12
P399600	45 x 14 x 8,5	0,45 x 6	35,40	12

16.2 Wine complements

Complementos de vino
Accessoires de vin

P985 Bottle stopper
Tapón botella
Bouchon bouteille



REF	Ø cm	H cm	€/ u	
P985000	3	5,5	3,50	200

46622 Bottle coaster
Base para botellas
Sous-bouteille



NEW!

REF	Ø cm	€/ u	
46622	15,6	13,85	24

46789 Waiter's corkscrew
Sacacorchos camarero
Tire-bouchon limonadier



NEW!

REF	L cm	€/ u	
46789	11,7	8,95	12

P9845 Wall-mounted corkscrew
Sacacorchos de pared
Tire-bouchon mural



P983 Ring stop drop
Anillo anti-goteo
Stop gouttes



REF	Ø cm	H cm	€/ u	
P983000	4	2	2,45	1

P984 Double-lever corkscrew
Sacacorchos doble palanca
Tire-bouchon double levier



REF	cm	€/ u	
P984100	17 x 6	7,80	144

47602 Pulltap's™ Kellnermesser corkscrew
Sacacorchos camarero Pulltap's™
Tire-bouchon de serveur Pulltap's™



PATENTED

Double lever
Palanca doble
Double levier

Five turn Teflon® coated forged steel. Internal cutting blade.
Acero forjado revestido de Teflon®. Hoja de corte interior.
Acier forgé revêtu de Teflon® cinq tours. Lame coupante intérieure.

REF	Spirale / Espiral cm	L cm	€/ u	
47602	5,1	11,7	19,90	10

REF	W x D x H cm	€/ u	
P984500	8 x 26 x 32	88,20	6

Trays 16.2

Bandejas
Plateaux

P619 St/Steel round serving tray
Bandeja camarero en acero inox
Plateau limonadier en acier inox



Mirror finished
Pulido brillante
Polissage brillant



REF	Ø cm	€/ u	
P619002	35	19,15	1
P619000	40	23,45	1

P956 Non slip serving tray
Bandeja camarero antideslizante
Plateau de service antidérapant



Black and brown colour
Color Negro i marrón
Couleur noir et marron



REF	Ø cm	€/ u	
P956035	35	7,95	12
P956040	40	9,75	12
P956135	35	7,95	12
P956140	40	9,75	12

1474 Non-Skid Trays
Bandeja camarero antideslizante
Plateau de service antidérapant

Non-slip
Antideslizante
Antidérapant

Black
Negro
Noir



REF	Ø cm	€/ u	
1474-0606	35,6	24,00	12
1476-0606	40,6	34,15	12

1612 Anti-Skid Mat Tray Accessories
Mantel antideslizante
Tapis antidérapant



REF	cm	€/ u	
1612-06	41 x 31,8	13,60	12
1420-01	Ø 31,8	14,95	12



SS
Stainless
steel

P8920B White creamer
Lechera blanca
Crémière blanche



REF	Lts	€ / u	
P892015B	0,15	9,00	1
P892035B	0,35	13,60	1
P892060B	0,60	18,80	1

P8920N Black creamer
Lechera negra
Crémière noire



REF	Lts	€ / u	
P892015N	0,15	9,00	1
P892035N	0,35	13,60	1
P892060N	0,60	18,80	1

P8920R Red creamer
Lechera roja
Crémière rouge



REF	Lts	€ / u	
P892015R	0,15	9,00	1
P892035R	0,35	13,60	1
P892060R	0,60	18,80	1

SS
Stainless
steel

P890 Tea pot with filter
Tetera con filtro
Théière avec filtre



REF	Lts	€ / u	
P890025	0,25	14,30	72
P890035	0,35	18,65	36
P890060	0,60	24,50	36

P891 Coffee pot with filter
Cafetera con filtro
Cafetière avec filtre



REF	Lts	€ / u	
P891035	0,35	17,15	36
P891060	0,60	23,45	36
P891100	1,00	30,55	36

P892 Creamer
Lechera
Crémière



REF	Lts	€ / u	
P892015	0,15	7,25	72
P892025	0,25	10,10	72
P892035	0,35	11,75	36
P892060	0,60	16,70	36
P892100	1,00	22,40	36
P892150	1,50	29,80	24
P892200	2,00	36,80	24

P893 Sugar bowl with lid
Azucarero con tapa
Sucrier avec couvercle



REF	Lts	€ / u	
P893025	0,25	10,60	72
P893035	0,35	11,95	72

16.3 Cosmos

P885 Tea pot with filter
Tetera con filtro
Théière avec filtre



REF	Lts	€ / u	
P885025	0,25	23,35	108
P885040	0,40	28,20	36
P885060	0,60	33,55	36

P886 Coffee pot with filter
Cafetera con filtro
Cafetière avec filtre



REF	Lts	€ / u	
P886035	0,35	27,25	36

P887 Creamer
Lechera
Crémère

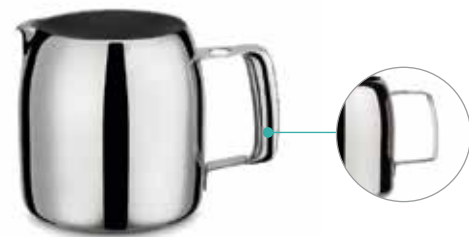

REF	Lts	€ / u	
P887015*	0,15	9,40	72
P887025*	0,25	15,95	72
P887060	0,60	22,00	36
P887100	1,00	36,75	24

* Special handle design for refs. P887015 and P887025 for a better handling.
Diseño especial asas refs. P887015 y P887025 para facilitar el manejo.
Spécial design pour anses ref. P887015 et P887025 des améliorer la prise en main.

Atlantis

SS
Stainless
steel

P880 Tea pot with filter
Tetera con filtro
Théière avec filtre



REF	Lts	€ / u	
P880035	0,35	35,70	50
P880050	0,50	42,25	50

P881 Coffee pot with filter
Cafetera con filtro
Cafetière avec filtre



REF	Lts	€ / u	
P881100	1,00	54,95	1

P882 Creamer
Lechera
Crémère



REF	Lts	€ / u	
P882015	0,15	11,75	50
P882035	0,35	19,70	50
P882100	1,00	37,30	50

Tea pots 16.3

Teteras
Théières



P23003 "Japan" tea pot
Tetera "Japón"
Théière "Japon"

CI
Cast
Iron



Cast iron.
Hierro fundido.
Fonte en fer.

Enameled inside.
Esmaltado interior.
Intérieur émaillé.



With St/Steel filter.
Con filtro de acero inoxidable.
Avec filtre en acier inoxydable.

REF	Filter / Filtro / Filtre Ø cm	Lts	€ / u	
P23003	7,0	0,35	32,80	12
P23004	8,0	0,80	47,05	8

P23015 "Kenya" tea pot
Tetera "Kenya"
Théière "Kenya"

CI
Cast
Iron



Cast iron.
Hierro fundido.
Fonte en fer.

Enameled inside.
Esmaltado interior.
Intérieur émaillé.



With St/Steel filter.
Con filtro de acero inoxidable.
Avec filtre en acier inoxydable.

REF	Filter / Filtro / Filtre Ø cm	Lts	€ / u	
P23015	7,0	0,30	35,15	12

P23008 "Nipon" tea pot
Tetera "Nipon"
Théière "Nipon"

CI
Cast
Iron



Cast iron.
Hierro fundido.
Fonte en fer.

Enameled inside.
Esmaltado interior.
Intérieur émaillé.



With St/Steel filter.
Con filtro de acero inoxidable.
Avec filtre en acier inoxydable.

REF	Filter / Filtro / Filtre Ø cm	Lts	€ / u	
P23008	7,0	0,30	28,30	12
P23009	8,0	0,60	37,90	8

P896 Coffee maker - herbal tea jug
Jarra para infusiones
Pot à infusions

SS
Stainless
steel

Cr
Crystal



+100°C

To remove the glass it is
necessary to unscrew.
Para sacar el cristal es
necesario desatornillar.
Pour enlever le verre il est
nécessaire de dévisser.

REF	Lts	€ / u	
P896003	0,35	15,60	30
P896008	0,80	21,00	24

16.4 Servers

Servidores
Verseuses



Servers 16.4

Servidores
Verseuses

P894 Airpot thermo inox with feeder

Termo con dosificador
Verseuse à pompe



Rotative base.
Base rotativa.
Fond rotatif.

Inner side in St/Steel
Interior en acero inoxidable
Intérieur en acier inoxydable

REF	Lts	€ / u	
P894003	3,00	60,00	6
P894004	4,00	67,30	6
P894005	5,00	73,45	6

P896 Airpot thermo inox with feeder

Termo inox con dosificador
Verseuse à pompe thermo inox



Rotative base.
Base rotativa.
Fond rotatif.

Inner side in St/Steel
Interior en acero inoxidable
Intérieur en acier inoxydable

REF	Lts	€ / u	
P896001	1,9	54,30	1
P896002	3,0	62,60	1

P337 Luxe insulated coffee pot

Jarra termo luxe
Pichet isolant luxe

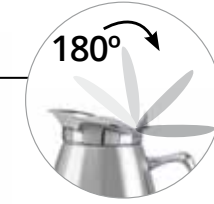

Inner side in St/Steel
Interior en acero inoxidable
Intérieur en acier inoxydable

IDEA! Ideal for dishwasher.
Ideal para lavavajillas.
Ideal pour lave-vaisselle.

REF	Lts	€ / u	
P337030	0,30	51,55	12
P337060	0,60	57,05	12
P337090	0,90	64,55	12
P337150	1,50	81,00	12
P337200	2,00	103,15	12

P895 Vacuum jug

Servidor termo
Verseuse thermo



Inner side in St/Steel
Interior en acero inoxidable
Intérieur en acier inoxydable



REF	Lts	€ / u	
P895006	0,60	22,05	6
P895010	1,00	25,35	6
P895015	1,50	29,45	6
P895020	2,00	32,05	6

P898 Thermo jug

Jarra termo
Pichet isotherme



dishwasher



Inner side in glass
Interior en vidrio
Intérieur en veurre

REF	Colour / Color	Lts	€ / u	
P898001		1	18,80	1
P898002		1	18,80	1

52172 Hot-N-Cold SWIRLSERVE®

Servidor termo Hot-N-Cold
Pichet isotherme Hot-N-Cold



dishwasher microwave



Looks like porcelain
Aspecto cerámico
Ressemble à la
porcelaine

With orange, brown, and white tabs allow easy differentiation.
Con pestañas de color naranja, marrón o blanca que permiten
diferenciar fácilmente.
Avec pousoirs orange, marron ou blanc pour une meilleure
différenciation.

REF	Colour / Color	Lts	€ / u	
52172		0,60	25,90	12
52162		0,60	25,90	12
52170		1,25	37,75	12
52160		1,25	37,75	12
52174		1,90	58,10	6
52164		1,90	58,10	6

16.4 Pitchers

Jarras
Pichets



Pitchers

Jarras
Pichets

46599 Server without lid
Jarra bombada con retén
Pichet bombé avec retenu

SS
Stainless steel

NEW!



REF	Lts	€/u	
46599	1,8	127,00	1

P335 Server without lid
Jarra bombada con retén
Pichet bombé avec retenu

SS
Stainless steel



REF	Lts	€/u	
P335002	1,8	37,05	20

Pitchers 16.4

Jarras
Pichets

P6464 Server
Jarra
Pichet

PC
Polycarbonate



Tube for ice
Tubo para hielo
Tube pour les glaçons

IDEA!

Ideal for juices.
Ideal para zumos.
Idéal pour des jus.

REF	Lts	€/u	
P646400	1,9	28,50	6

P6442 Server
Jarra
Pichet

EXCLUSIVE

100% BPA FREE
NON-TOXIC PLASTIC

Made of SAN.
Fabricada en SAN.
Fabriquée en SAN.

+80°C



REF	Lts	€/u	
P644200	1,00	8,50	12
P644240	1,40	9,65	12
P644275	1,75	11,10	12

P6463 Polypropylene lid for stackable Server
Tapa polipropileno para jarra apilable
Couvercle polypropylène pour pichet empilable

PC
Polycarbonate

REF	Color / Colour	Lts	€/u	
P646300	Blue	1	2,95	24
P646310	Grey	1	3,15	24
P646301	Blue	2	3,25	12

P649 Carafe tritan
Jarra agua tritan
Carafe en tritan

Tr
Tritan

EXCLUSIVE

100% BPA FREE
NON-TOXIC PLASTIC



REF	Lts	€/u	
P649050	0,50	12,85	1
P649100	1,00	16,50	1

P646 Stackable polycarbonate server without lid
Jarra policarbonato apilable sin tapa
Pichet polycarbonate empilable sans couvercle

PC
Polycarbonate



REF	Color / Colour	Lts	€/u	
P646100	Blue	1	9,80	24
P646103	Blue	1	11,80	24
P646105	Green	1	11,80	24
P646200	Blue	2	16,35	24

Fits only on the stackable polycarbonate servers P646.
Sólo para jarra policarbonato apilable sin tapa P646.
Adaptables uniquement sur les pichets polycarbonate empilables P646.

16.5 Lidsavers and cupdispensers

Dispensadores de tapas y vasos
Distributeur de couvercles et gobelets



LIDSAVER™ 3

SANITARY SOLUTIONS

- Sanitary dispensing system helps eliminate contamination from excess handling.
- Keeps operations clean and tidy, addressing major consumer concerns about health and well-being.

SOLUCIONES HIGIÉNICAS

- El sistema de dispensado higiénico previene la contaminación por manipulación excesiva.
- Mantiene las operaciones limpias y ordenadas y responde a las inquietudes de los consumidores en cuanto a salud y bienestar.

SOLUTIONS HYGIÉNIQUES

- Ce système de distribution hygiénique empêche la contamination causée par une manipulation excessive.
- Maintient les locaux propres et ordonnés, répondant ainsi aux principaux soucis des clients en ce qui concerne la santé et le bien-être.

CUSTOMER BENEFITS

- A welcome environment that is clean and tidy.
- Noticeably more hygienic service fosters customer goodwill.
- Simple-to-use design allows customers to fill beverages and put on a lid using only one hand.

BENEFICIOS PARA LOS CLIENTES

- Un ambiente agradable, limpio y ordenado.
- Un servicio notablemente más higiénico fomenta la buena voluntad de los clientes.
- El diseño fácil de usar permite a los clientes llenar bebidas y poner la tapa usando una sola mano.

AVANTAGES POUR LE CLIENT

- Un cadre accueillant, propre et ordonné.
- Un service de toute évidence plus hygiénique dope les ventes.
- Utilisation simple et facile qui permet aux clients de remplir leur gobelet de boisson et de mettre le couvercle d'une seule main.

COST SAVINGS

- Fewer wasted lids adds up to more savings.
- Counters are kept free of stacks of new lids and messy rejected lids, requiring less labor for cleanup.

AHORROS

- Menos pérdidas de tapas significan más ahorro.
- Los mostradores se mantienen libres de pilas de tapas nuevas y tapas rechazadas, desordenadas, lo cual se traduce en menos trabajo de limpieza.

ÉCONOMIES

- Moins de couvercles gaspillés, ce qui se traduit par plus d'économies.
- Les comptoirs ne sont pas encombrés par des piles de couvercles neufs et des couvercles usagés et sales, ce qui demande moins de main-d'oeuvre pour le nettoyage.

UP TO 30% COST SAVINGS

AHORRAR HASTA UN 30% DE LOS COSTES
ÉCONOMISEUR DE 30% DES COÛTS



Lidsavers and cupdispensers 16.5

Dispensadores de tapas y vasos
Distributeur de couvercles et gobelets



Lidsaver™ 3

Assembly Montaje Montage

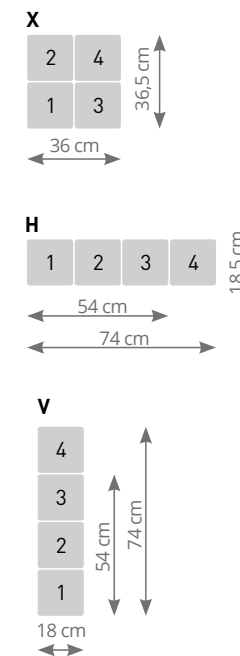

T1 (L)

Lids / Tapas / Couvercles
LS03 K / LS03 M

Model / Modelo	Code / Código
Berry™ DLT1310 Domed	AB
Berry™ DLT1310SS	AC
Berry™ DLT1402 Domed	AD
Berry™ DLT1402SS	AE
Berry™ DLT1408 Domed	AF
Berry™ DLT1408SS	AG
Dart® 16EL	AJ
Dart® 16LCDH	AK
Dart® 16RCL	AL
Dart® 16SL	AM
Dart® 20SL	AN
Dart® 20SLR	AO
Dart® 32SL	AP
Dart® 32SLR	AQ
Dixie® 9542	AR
Dixie® 955	JY
Dixie® TP9542	AS
Dixie® TP9550	JZ
International Paper LCRS 32	AT
International Paper LCTS 44	AU
Sweetheart® LGX12R	AY
Solo® 626	AZ
Solo® DL626	BB
Solo® DLR642	BC
Solo® LD16A	BD

T2 (C)

Cup dispenser
Dispensador vaso
Distributeur de gobelets

REF	Code / Código	Type / Tipo	€/u
INC-80	A	Plastic / Plástico	139,10
CADJ-3	D	St/Steel / Inox	179,40

T3 (S)

Straw dispenser
Dispensador de pajitas
Distributeur de pailles

REF	Code / Código	€/u
S1	S	121,20

T4 (P)

Condiment pocket
Apartado para condimentos
Casier à condiments

REF	Code / Código	€/u
P1	P	121,20

For other lid models, consult your dealer.
Para otros modelos de tapa, consultar a su comercial.
Pour d'autres modèles de couvercles, consulter votre agent.



LS03 K Lids and cups dispenser display Mueble dispensador tapas y vasos Meuble distributeur couvercles et gobelets

REF + TYPE + CODE K4V-LLCC-AB-AD-A-A



REF	Tipo / Type	Code / Código
K1	L	T1
K2H	LL	T1 + T1
K2H	LC	T1 + T2
K2V	LP	T1 + T4
K3H	LLL	T1 + T1 + T1
K3H	LCC	T1 + T2 + T2
K3V	LCS	T1 + T2 + T3
K3V	LCP	T1 + T2 + T4
K4H	LCCC	T1 + T2 + T2 + T2
K4H	LCCS	T1 + T2 + T2 + T3
K4V	LCCP	T1 + T2 + T2 + T4
K4V	LLCC	T1 + T1 + T2 + T2
K4X	LCCC	T1 + T2 + T2 + T2
K4X	LCCS	T1 + T2 + T2 + T3
K4X	LCCP	T1 + T2 + T2 + T4
K4X	LLCC	T1 + T1 + T2 + T2

LS03 M Vertical lids dispenser display Mueble dispensador tapas vertical Meuble distributeur couvercles vertical

REF + CODE M2V-LL-AB-AE



REF	Code / Código	H cm
M1-L	+T1	18,5
M2V-LL	+T1 + T1	36,5
M3V-LLL	+T1 + T1 + T1	54,0
M4V-4L	+T1 + T1 + T1 + T1	74,0

16.5 Lidsavers and cupdispensers

Dispensadores de tapas y vasos
Distributeur de couvercles et gobelets

KDS Lids and cups dispenser organizer display
Mueble dispensador tapas y vasos con organizador
Meuble distributeur couvercles et gobelets avec organisateur



REF	Code / Código	H cm	📦
K1LLDS	T1	42,5	1
K2VLLCLS	T1 + T2	60,5	1
K2VLLDS	T1 + T1	60,5	1
K3VLLCLS	T1 + T2 + T2	78,5	1

Lidsaver™ 3 MINI

T5 (L)

Lids / Tapas / Couvercles
LS03J / LS03M

Type / Tipo Code Código

Dart® Solo® P150	M9
Dart®/Solo® PL2	N1
Natureworks Inego PLA 3.085/310	YQ
International Paper LCM-12S	D9
International Paper LCWS12	XE
International Paper LCRS 12	EQ
International Paper LHSL-8	XK
Pactiv YLP10C	ZD
Solo® L10BL	ST
Solo® PL4	ZN
Solo® TL3-8	IT
Solo®TLRN38	ZM
Sweetheart® DLX8R	GV
SUP-10D	YT
Quick 6 Oz. BIS-H	YH
WinCup® 6L STYROLID	VG

For other lid models, consult your dealer.
Para otros modelos de tapa, consultar a su comercial.
Pour d'autres modèles de couvercles, consulter votre agent.

LS03 Lids In-counter dispenser
Dispensador encastrable tapas
Distributeur encastrable couvercles

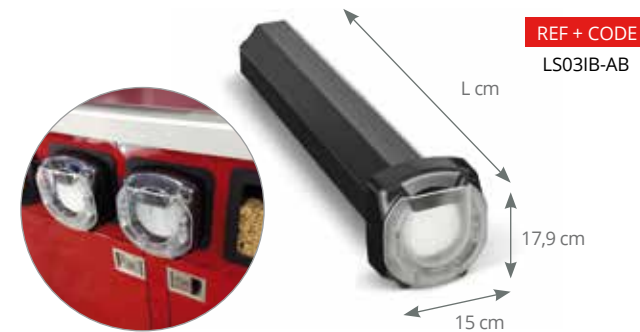

REF	Code Código	Posiciones Posiciones	L cm	For / Para / Pour cm	📦
LS03IB	T1	H	58,5	8,3 - 9,5	1
LS03IVB	T1	V	58,5	8,3 - 9,5	1
LS03PB	T1	H	58,5	9,7 - 12,1	1
LS03PVB	T1	V	58,5	9,7 - 12,1	1
LS03IS18B	T1	H	45,5	8,3 - 9,5	1
LS03PS18B	T1	H	45,5	9,7 - 12,1	1

LS03 J Mini lid dispenser display
Mueble dispensador mini tapas
Meuble distributeur mini couvercles



REF	Type / Tipo	Code / Código	B x H cm
J1	L	T5	13,5 x 19,1
J2V	LL	T5 + T5	13,5 x 36,0
J2H	LL	T5 + T5	28,5 x 19,1
J3V	LLL	T5 + T5 + T5	13,5 x 52,5

LS03 M Mini lid In-counter dispenser
Dispensador encastrable mini tapas
Distributeur encastrable mini couvercles



REF	Code / Código	Posiciones Posiciones	L cm	📦
LS03MS18B	T5	H	45,5	1
LS03MVS18B	T5	V	45,5	1

For / Para / Pour : 4,4 - 8,3 cm

Lidsavers and cupdispensers 16.5

Dispensadores de tapas y vasos
Distributeur de couvercles et gobelets

RSCL Lids and cups dispenser
Dispensador vasos y tapas
Distributeur gobelets et couvercles



REF	L cm	Ø cm	For / Para / Pour cm	€/ u	📦
RSCL-4	38	101,5	-	390,15	1
LD2-2	11	65,0	10,5	100,10	1
LD3-2	13	65,0	12,4	118,70	1
PLC-1	8	65,5	5,7 - 7,3	80,65	1
PLC-2	9,5	65,5	7,3 - 8,9	91,30	1
PLC-3	11	65,5	8,9 - 10,5	96,80	1

INC / CADJ Cup dispenser
Dispensador vaso
Distributeur de gobelets



REF	L cm	Ø cm	For / Para / Pour cm	€/ u	📦
INC-80	58,5	13,5	5,7 - 12,1	139,10	1
INC-80S18	46,0	13,5	5,7 - 12,1	140,95	1
CADJ-1	56,0	13,5	6,4 - 8,9	162,20	1
CADJ-2	56,0	14,5	7,6 - 9,8	175,55	1
CADJ-3	56,0	17,5	7,6 - 11,7	179,40	1

3825 Straw dispenser
Dispensador de pajitas
Distributeur de pailles



REF	W x D x H cm	€/ u	📦
3805-06	31 x 36,7 x 17,8	110,00	1
3820-28	32 x 14 x 18	160,00	1

16.5 Lidsavers and cupdispensers

Dispensadores de tapas y vasos
Distributeur de couvercles et gobelets

G58807 Countertop dispenser
Dispensador de mostrador
Distributeur de comptoir



4 adjustable cup dispenser
4 T-lid holder
1 straw holder

Dispensador ajustable de 4 tazas
Soporte para 4 tapas en T
1 portapajillas

4 distributeurs de gobelets réglables
4 porte-couvercle en T
1 porte-pailles

REF	W x D x H cm	€ / u	📦
G58807	36,2 x 62,5 x 80,5	1.426,10	1

4830-06 Three-tier self-serve dispenser
Dispensador autoservicio de tres niveles
Distributeur libre-service à trois niveaux



REF	W x D x H cm	€ / u	📦
4830-06	14,3 x 30 x 35	51,00	1

4842 Self-Serve dispenser system
Dispensador auto-servicio
Système distributeur libre-service



4842-01 4806-06

CTCL-4B Four-compartment countertop cup and lid organizer
Organizador de sobremesa de vasos y tapas con cuatro compartimentos
Présentoir de comptoir à quatre compartiments pour gobelets et couvercles



REF	W x D x H cm	€ / u	📦
CTCL-4B	15,4 x 57,2 x 53,3	259,00	1

CTFWH-8B Eight compartment flatware organizer
Organizador de cubiertos de 8 compartimentos
Range-couverts à 8 compartiments



REF	W x D x H cm	€ / u	📦
CTFWH-8B	25,6 x 46 x 43,7	320,00	1

Idea! Ideal for flatware, tea, condiment packets, salt, pepper, and products with high-volume usage.

Ideal para cubiertos, te, condimentos, sal, pimienta y para todo tipo de productos de mucha rotación.

Idéal pour couverts, thé, condiments, sel, poivre et toute sorte de produits à usage intensif.

REF	Color / Colour	W x D x H cm	€ / u	📦
4806-01	🟤	13 x 28,5 x 11	17,75	1 NEW
4806-06	⬛	13 x 28,5 x 11	17,40	1
4842-01	🟤	14,3 x 40,6 x 35,2	82,00	1 NEW

Lidsavers and cupdispensers 16.5

Dispensadores de tapas y vasos
Distributeur de couvercles et gobelets

CTNO Condiment dispensers
Dispensadores de condimentos
Distributeurs de condiments

*Adjustable compartments
Divisores ajustables
Compartiments réglables



CTNO-06

REF	W x D x H cm	Capacity Capacidad Capacité	Napkin Servilletas Serviettes cm	€ / u	📦
CTNO-06*	24,5 x 49,0 x 38,5	100	12,5 x 16,5 11,5-12,5 x 16,5	505,50	1

LDS Condiment dispensers
Dispensador de condimentos
Distributeur de condiments



CFIFO-4

CTC-3X2V



LDS-3

LDS-4CUP

REF	W x D x H cm	€ / u	📦
CFIFO-4	42,2 x 25,6 x 42	322,00	1 NEW
LDS-4CUP*	29,5 x 53,5 x 51,5	386,20	1
CTC-3X2V**	29 x 27 x 41,5	294,60	1
LDS-3	18,4 x 61 x 24,4	360,00	1 NEW

* For lids and cups
Para tapas y vasos
Pour couvercles et gobelets
Ø 12 cm

**Adjustable dividers
Divisores ajustables
Séparateurs réglables

VENTA

Precio: Los precios se reflejan en el P.V.P. **Impuestos:** Se cargarán en la factura (IVA-I.G.I.C.- etc.).

Transporte: Los costes de transporte se calculan siempre por transporte.

Pago: Se debe realizar un pago del 100% con cada pedido, también los gastos de transporte se deben pagar antes del envío del pedido, al recibir la factura.

Entrega: se realiza en la dirección indicada en la entrada, en la planta baja.

Embalaje: Cualquier embalaje especial se facturará junto con la cotización.

Pedidos: Se confirman por escrito con cualquier tipo de gas y voltaje.

Reserva de dominio: La venta está sujeta a reserva de dominio hasta el pago total del importe correspondiente. **Cancelación de Pedidos:** Los costos derivados de la cancelación o modificación de pedidos son responsabilidad del comprador; No se aceptarán cancelaciones de pedidos especiales una vez iniciada la producción.

GARANTIA

HIG ofrece a sus clientes una garantía de 12 meses en todos sus dispositivos.

1. Los costes laborales no están cubiertos en ningún caso.
2. La garantía es de doce meses a partir de la fecha de factura y cubre las piezas defectuosas, cuya sustitución corre a cargo del comprador.
3. La garantía no cubre piezas eléctricas, accesorios u otros componentes separables.
4. Los posibles daños debidos al transporte o a una instalación o mantenimiento inadecuados no se consideran motivo válido a efectos de garantía.
6. La garantía se aplica únicamente al comprador original y no cubre el reemplazo del dispositivo.
5. El mantenimiento normal y las reparaciones debidas a una instalación incorrecta no están cubiertos por la garantía.
6. La garantía se aplica únicamente al comprador original y no cubre el reemplazo del dispositivo.

DEVOLUCIÓN DE BIENES

1. No se aceptarán devoluciones sin nuestra aprobación previa, que incluirá un número de referencia que se incluirá en el albarán de entrega y etiquetas de envío.
2. Las devoluciones se realizan siempre de forma gratuita.
3. En caso de devolución por error de envío o por causas imputables a Bonast, los gastos de envío adeudados serán aceptados por la agencia que le indicaremos previa aprobación.
4. Las devoluciones deberán indicar el número de factura y la fecha de acuerdo con el Real Decreto 1496/2003, de 28 de noviembre.
5. No se realizará ningún pago por máquinas que no estén en condiciones de reventa o que no estén en la caja o embalaje original. Así como máquinas especiales personalizadas.
6. No se aceptarán devoluciones de ningún tipo de máquina dentro del mes siguiente a la fecha de compra.
7. Por cada envío de devolución (por error del cliente), se debitará de la mercancía el 15% del valor neto de la factura, como contribución a nuestros costes de revisión y embalaje.
8. En ningún caso se aceptarán devoluciones masivas de máquinas (liquidación de stock, cambios de almacén, etc.).
9. Importante: La mercancía sale de nuestros almacenes en perfecto estado, por lo que si llega dañada deberás presentar una reclamación a la empresa de transporte en un plazo de 24 horas para reclamar el desperfecto.

Los precios, características técnicas y fotografías de los artículos de este catálogo están sujetos a cambios sin previo aviso.



CONDITIONS DE VENTE GARANTIES ET POLITIQUE DE RETOUR



VENTE

Prix : Les prix sont reflétés dans le P.V.P. Taxes : Celles-ci seront facturées sur la facture (TVA-I.G.I.C.- etc.).

Transport : Les frais de transport sont toujours calculés par transport.

Paiement : Le 100% doit être versé à chaque commande, ainsi que les frais de transport doivent être réglés avant l'expédition de la ou des commande(s), à réception de la facture.

Livraison : s'effectue à l'adresse indiquée, à l'entrée, au rez-de-chaussée.

Emballage : Tout emballage particulier sera facturé avec le devis. Pièces de rechange et accessoires : toujours contre remboursement et les frais d'expédition sont dus. Production spéciale : 60% seront facturés lors de la commande.

Commandes : Elles sont confirmées par écrit avec tout type de gaz et toute tension.

Réserve de propriété : La vente est soumise à réserve de propriété jusqu'au paiement intégral du montant correspondant. Annulation de commandes : Les frais résultant de l'annulation ou de la modification des commandes sont à la charge de l'acheteur ; Les annulations de commandes spéciales ne seront pas acceptées une fois la production commencée.

GARANTIE

HIG offre à ses clients une garantie de 12 mois sur tous ses appareils.

1. Les frais de main d'œuvre ne sont en aucun cas couverts.
2. La garantie est de douze mois à compter de la date de facture et couvre les pièces défectueuses dont le remplacement est à la charge de l'acheteur.
3. La garantie ne couvre pas les pièces électriques, accessoires ou autres composants séparables.
4. Les dommages possibles dus au transport ou à une installation ou un entretien inappropriés ne sont pas considérés comme une raison valable aux fins de la garantie. 6. La garantie s'applique uniquement à l'acheteur d'origine et ne couvre pas le remplacement de l'appareil.
5. L'entretien normal et les réparations dues à une mauvaise installation ne sont pas couverts par la garantie.
6. La garantie s'applique uniquement à l'acheteur d'origine et ne couvre pas le remplacement de l'appareil.

RETOUR DES MARCHANDISES

1. Aucun retour ne sera accepté sans notre accord préalable, qui comportera un numéro de référence à inclure sur le bon de livraison et les étiquettes d'expédition.
2. Les retours sont toujours effectués gratuitement.
3. En cas de retour dû à une erreur d'expédition ou pour des raisons imputables à Bonast, les frais d'expédition dus seront acceptés par l'agence que nous indiquerons avec accord préalable.
4. Les retours doivent indiquer le numéro et la date de la facture conformément au décret royal 1496/2003 du 28 novembre.
5. Aucun paiement ne sera effectué pour les machines qui ne sont pas dans un état revendable ou qui ne sont pas dans leur boîte ou emballage d'origine. Ainsi que des machines spéciales personnalisées.
6. Les retours de tout type de machine ne seront pas acceptés dans le mois suivant la date d'achat.
7. Pour chaque retour (en raison d'une erreur du client), la marchandise sera débitée de 15 % de la valeur nette de la facture, à titre de contribution à nos frais de révision et d'emballage.
8. En aucun cas les retours massifs de machines ne seront acceptés (règlement de stock, changement d'entrepôt, etc.).
9. Important : Les marchandises quittent nos entrepôts en parfait état, donc si elles arrivent endommagées, vous devez déposer une réclamation auprès du transporteur dans les 24 heures pour réclamer les dommages.

Les prix, caractéristiques techniques et photographies des articles de ce catalogue sont sujets à changement sans préavis.

SALE

Price: Prices are reflected in the P.V.P. Taxes: These will be charged on the invoice (VAT-I.G.I.C.- etc.).

Transport: Transport costs are always calculated per transport.

Payment: A payment of 100% must be made with each order and the transport costs must be paid before the order(s) are shipped, upon receipt of the invoice.

Delivery: takes place at the address indicated, at the entrance, on the ground floor.

Packaging: Any special packaging will be invoiced with the quotation.

Orders: These are confirmed in writing with any gas type and voltage.

Retention of title: The sale is subject to retention of title until full payment of the corresponding amount. Cancellation of Orders: Costs resulting from cancellation or modification of orders are the responsibility of the buyer; Cancellations of special orders will not be accepted once production has begun..

GUARANTEE

HIG offers its customers a 12-month warranty on all its devices.

1. Labor costs are not covered under any circumstances.
2. The warranty is twelve months from the date of invoice and covers defective parts, the replacement of which is at the expense of the buyer
3. The warranty does not cover electrical parts, accessories or other separable components.
4. Possible damage due to transportation or improper installation or maintenance is not considered a valid reason for warranty purposes. . The warranty applies to the original purchaser only and does not cover the replacement of the device.
5. Normal maintenance and repairs due to improper installation are not covered by the warranty.
6. The warranty applies to the original purchaser only and does not cover the replacement of the device.

RETURN OF GOODS

1. No returns will be accepted without our prior consent, which will include a reference number

which must be stated on the delivery note and shipping labels.

2. Returns are always made free of charge.

3. In the event of a return due to a shipping error or for reasons attributable to Bonast the shipping costs due will be accepted by the agency that we will indicate with prior approval.

4. Returns must indicate the invoice number and date in accordance with Royal Decree 1496/2003 of November 28.

5. No payment will be made for machines that are not in resalable condition or not in the original box or packaging.

As well as special personalized machines.

6. Returns of any type of machine will not be accepted within one month of the date of purchase.

7. With each return shipment (due to a customer error), the goods will be debited by 15% of the net invoice value, if

contribution to our overhaul and packaging costs.

8. Under no circumstances will mass returns of machines be accepted (stock settlement, warehouse changes, etc.).

9. Important: The goods leave our warehouses in perfect condition, so if they arrive damaged, please contact us within 24 hours

file a claim with the transport company to claim the damage.

Prices, technical characteristics and photographs of items in this catalog are subject to change without notice

Read and approved

HIG

Horeca Industry *Group*

HIG

Horeca Industry *Group*

